



X3-FORTH SERIES USER MANUAL

40kW - 150kW



SolaX Power Network Technology (Zhejiang) Co., Ltd.

No.288, Shizhu Road, Tonglu Economic Development Zone, Tonglu City, Zhejiang Province, 310000 P. R. CHINA
Tel: +86 (0) 571-5626 0011
E-mail: info@solaxpower.com

320101031205

EN

Copyright Declaration

The copyright of this manual belongs to SolaX Power Network Technology (Zhejiang) Co., Ltd. Any corporation or individual should not plagiarize, partially or fully copy (including software, etc.), and no reproduction or distribution of it in any form or by any means. All rights reserved. SolaX Power Network Technology (Zhejiang) Co., Ltd. reserves the right of final interpretation.

www.solaxpower.com

CONTENTS

1	NOTE ON THIS MANUAL.....	03
1.1	SCOPE OF VALIDITY.....	03
1.2	TARGET GROUP.....	03
1.3	SYMBOLS USED.....	03
2	SAFETY.....	04
2.1	APPROPRIATE USAGE.....	04
2.2	IMPORTANT SAFETY INSTRUCTIONS.....	05
2.3	EXPLANATION OF SYMBOLS.....	08
2.4	EC DIRECTIVES.....	09
3	INTRODUCTION.....	10
3.1	PHOTOVOLTAIC GRID CONNECTED SYSTEM.....	11
3.2	BASIC FEATURES.....	13
3.3	OVERVIEW OF THE INVERTER.....	13
3.4	DIMENSION	14
3.5	PRINCIPLE DESCRIPTION.....	15
4	TECHNICAL DATA.....	16
4.1	DC INPUT.....	16
4.2	AC OUTPUT.....	17
4.3	EFFICIENCY, SAFETY AND PROTECTION.....	18
4.4	GENERAL DATA	19
5	MECHANICAL INSTALLATION.....	20
5.1	INSTALLATION PRECAUTION.....	20
5.2	SELECTION FOR THE INSTALLATION POSITION.....	20
5.2.1	INSTALLATION ENVIRONMENT REQUIRED.....	21
5.2.2	INSTALLATION CARRIER REQUIRED.....	21
5.2.3	INSTALLATION ANGLE REQUIRED.....	22
5.2.4	INSTALLATION SPACE REQUIRED.....	23
5.3	TOOLS PREPARATION.....	24
5.4	CHECK FOR TRANSPORT DAMAGE	25
5.5	PACKING LISTS.....	25

- 5.6 INSTALLATION STEPS.....26
 - 5.6.1 INSTALLATION STEPS (ON THE WALL)26
 - 5.6.2 INSTALLATION STEPS (ON THE STAND).....27
- 6 ELECTRICAL CONNECTION.....29
 - 6.1 GROUNDING CONNECTION.....29
 - 6.2 PV STRING CONNECTION.....30
 - 6.3 GRID CONNECTION.....33
 - 6.4 COMMUNICATION CONNECTION.....36
 - 6.4.1 COMMUNICATION SIGNAL DEFINITION.....36
 - 6.4.2 CONNECTION STEPS OF CABLE.....37
 - 6.4.3 RELEASE STEPS OF CABLE.....38
 - 6.5 PLC BOX CONNECTION (OPTIONAL).....39
 - 6.6 MONITORING CONNECTION.....39
- 7 STARTUP OF THE INVERTER.....43
- 8 FIRMWARE UPGRADING.....46
- 9 SETTING.....48
- 10 TROUBLESHOOTING.....57
 - 10.1 TROUBLESHOOTING.....59
 - 10.2 ROUTINE MAINTENANCE.....64
- 11 DECOMMISSIONING.....66
 - 11.1 DISMANTLING THE INVERTER.....66
 - 11.2 PACKAGING.....66
 - 11.3 STORAGE AND TRANSPORTATION.....66
 - 11.4 DISPOSING OF THE INVERTER.....66
- 12 DISCLAIMER67
- * WARRANTY REGISTRATION FORM

1 Notes on this Manual

1.1 Scope of Validity

This manual is an integral part of X3-FORTH series, It describes the assembly, installation, commissioning, maintenance and failure of the product. Read it carefully before operating.

X3-FTH-40K-LV	X3-FTH-50K-LV	X3-FTH-60K-LV	X3-FTH-70K-LV
X3-FTH-80K	X3-FTH-100K	X3-FTH-110K	X3-FTH-120K
X3-FTH-125K	X3-FTH-136K-MV	X3-FTH-150K-MV	

Note: “X3”: means three phases, “FTH” means FORTH, “80K” means 80 kW. Each model is available with LED indicator lights and LCD. 40kW/50kW/60kW/70kW inverters works in the 127 V / 220 V low voltage range. 80kW/100kW/110kW/120kW/125kW inverters works in the 220 V / 380 V voltage range. 136kW/150kW inverters works in the 500 V / 540 V medium voltage range.





Keep this manual at the place where it is accessible all the time.

1.2 Target Group

This manual is for qualified electricians. The tasks described in this manual only can be performed by qualified electricians.

1.3 Symbols Used

The following types of safety instructions and general information appear in this document as described below:

	<p>DANGER! “Danger” indicates a hazardous situation which, if not avoided, will result in death or serious injury.</p>
	<p>WARNING! “Warning” indicates a hazardous situation which, if not avoided, could result in death or serious injury.</p>
	<p>CAUTION! “Caution” indicates a hazardous situation which, if not avoided, could result in minor or moderate injury.</p>
	<p>NOTE! “Note” provides tips that are valuable for the optimal operation of your product.</p>

2 Safety

2.1 Appropriate Usage

The inverter are PV inverters which can convert the DC current of the PV generator into AC current and feed it into the public grid.

Surge protection devices (SPDs) for PV installation



WARNING!

- Over-voltage protection with surge arresters should be provided when the PV power system is installed.
- The grid connected inverter is fitted with SPDs in MAINS side.

Induced surges are the more likely cause of lightning damage in the majority of installations, especially in rural areas where electricity is usually provided by long overhead lines. Surges may be induced on both the PV array conductors or the AC cables leading to the building.

Specialists in lightning protection should be consulted in the actual application. Using appropriate external lightning protection, the effect of a direct lightning

Installation of SPDs to protect the inverter against mechanical damage and excessive stress include a surge arrester in case of a building with external lightning protection system (LPS) when separation distance is kept.

To protect the DC system, surge protection device (SPD type2) should be fitted at the inverter end of the DC cabling and at the array located between the inverter and the PV generator, if the voltage protection level (VP) of the surge arresters is greater than 1100V, an additional SPD type 3 required for surge protection for electrical devices.

To protect the AC system, surge protection devices (SPD type2) should be fitted at the main incoming point of AC supply (at the consumer's cutout) , located between the inverter and the meter / distribution system; SPD (test impulse D1) for signal line according to EN 61632-1.

All DC cables should be installed to provide as short a run as possible, and positive and negative cables of the string or main DC supply should be bundled together. Avoid creating loops in the system. This requirement for short runs and bundling includes any associated earth bundling conductors.

Spark gap protection devices are not suitable to be used in DC circuits once conducting, they won't stop conducting until the voltage passes through their terminals typically less than 30 volts.

- **Anti-Islanding Effect**

Islanding effect is a special phenomenon that grid-connected PV system still supplies power to the nearby grid when electrical grid power is no longer present. It is dangerous for maintenance personnel and the public.

The inverter provides Active Frequency Drift (AFD) to prevent islanding effect.

2.2 Important Safety Instructions



DANGER!
Danger to life due to high voltages in the inverter!

- All work must be carried out by qualified electrician.
- The appliance is not to be used by children or persons with reduced physical sensory or mental capabilities, or lack of experience and knowledge, unless they have been given supervision or instruction.
- Children should be supervised to ensure that they do not play with the appliance.



CAUTION!

- Danger of burn injuries due to hot enclosure parts!
- During operation, the upper lid of the enclosure and the enclosure body may become hot.
- Only touch the lower enclosure lid during operation.



CAUTION!

- Possible damage to health as a result of the effects of radiation!
- Do not stay closer than 20 cm to inverter for any length of time.



NOTE!

Grounding the PV generator.

- Comply with the local requirements for grounding the PV modules and the PV generator. We recommends connecting the generator frame and other electrically conductive surfaces in a manner which ensures continuous conduction and ground these in order to have optimal protection of system and persons.



WARNING!
 • Ensure input DC voltage \leq Max. DC voltage .Over voltage may cause permanent damage to inverter or other losses, which will not be included in warranty!



WARNING!
 • Authorized service personnel must disconnect both AC and DC power from the inverter before attempting any maintenance or cleaning or working on any circuits connected to the inverter.



WARNING!
 Do not operate the inverter when the device is running.



WARNING!
 Risk of electric shock!

- Prior to the application, please read this section carefully to ensure correct and safe application. Please keep the user manual properly.
- Use only attachments recommended. Otherwise may result in a risk of fire, electric shock, or injury to person.
- Make sure that existing wiring is in good condition and that wire is not undersized.
- Do not disassemble any parts of inverter which are not mentioned in installation guide. It contains no user-serviceable parts. See Warranty for instructions on obtaining service. Attempting to service the inverter yourself may result in a risk of electric shock or fire and will void your warranty.
- Keep away from flammable, explosive materials to avoid fire disaster.
- The installation place should be away from humid or corrosive substance.
- Authorized service personnel must use insulated tools when installing or working with this equipment.
- PV modules shall have an IEC 61730 class A rating.
- Never touch either the positive or negative pole of PV connecting device.
- Strictly prohibit touching both of them at the same time.
- The unit contains capacitors that remain charged to a potentially lethal voltage after the MAINS and PV supply has been disconnected.



WARNING!
 Hazardous voltage will present for up to 5 minutes after disconnection from power supply.

- CAUTION-RISK of electric shock from energy stored in capacitor. Never operate on the solar connectors, The MAINS cables, PV cables or the PV generator when power is applied. After switching off the PV and Mains, always wait for 5minutes to let the intermediate circuit capacitors discharge before you unplug DC and MAINS connectors.
- When accessing the internal circuit of solar inverter, it is very important to wait 5 minutes before operating the power circuit or demounting the electrolyte capacitors inside the device. Do not open the device beforehand since the capacitors require time to sufficiently discharge!

PE Connection and Leakage Current

- The inverter incorporates a certified internal Residual Current Device (RCD) in order to protect against possible electrocution and fire hazard in case of a malfunction in the cables or the inverter. There are two trip thresholds for the RCD as required for certification (IEC 62109-2: 2011) .
- The default value for electrocution protection is 30 mA, and for slow rising current is 300 mA.
- If an external RCD is required by local regulations, check which type of RCD is required for relevant electric code. It recommends using a type-A RCD. The recommended RCD values is 300 mA unless a lower value is required by the specific local electric codes. When required by local regulations, the use of an RCD type B is permitted.

The device is intended to connect to a PV generator with a capacitance limit of approx 700 nf.



WARNING!
 • High leakage current!
 • Earth connection essential before connecting supply.

- Incorrect grounding can cause physical injury, death or equipment malfunction and increase electromagnetic.
 - Make sure that grounding conductor is adequately sized as required by safety regulations.
 - Do not connect the ground terminals of the unit in series in case of a multiple installation. This product can cause current with a d.c component,
- For United Kingdom
- The installation that connects the equipment to the supply terminals shall comply with the requirements of BS 7671.
 - Electrical installation of PV system shall comply with requirements of BS 7671 and IEC 60364-7-712.

- No protection settings can be altered.
- Installer shall ensure that equipment is installed and operated to maintain at all times in compliance with the requirements of ESQCR22 (1) (a) .





For Australia and New Zealand

- Electrical installation and maintenance shall be conducted by licensed electrician and shall comply with Australia National Wiring Rules.





2.3 Explanation of Symbols







This section gives an explanation of all the symbols shown on the inverter and on the type label.

• Symbols on the Inverter

Symbol	Explanation
	Communication indicator
	DC connection indicator
	Grid connection indicator
	Alarm indicator

• Symbols on the Type Label

Symbol	Explanation
	CE mark. The inverter complies with the requirements of the applicable CE guidelines.
	TUV certified
	RCM remark
	UKCA mark. The inverter complies with the requirements of the applicable UKCA guidelines.
	UKNI mark. The inverter complies with the requirements of the applicable UKNI guidelines.

	Beware of hot surface. The inverter can become hot during operation. Avoid contact during operation.
	Danger of high voltages. Danger to life due to high voltages in the inverter!
	Danger. Risk of electric shock!
	Observe enclosed documentation.
	The inverter can not be disposed together with the household waste. Disposal information can be found in the enclosed documentation.
	Do not operate this inverter until it is isolated from mains and on-site PV generation suppliers.
	Danger to life due to high voltage. There is residual voltage in the inverter which needs 5 minutes to discharge. • Wait 5 minutes before you open the upper lid or the DC lid.

3. Introduction

3.1 Photovoltaic Grid Connected System

The inverter is a three-phase transformerless grid connected inverter. It is an important part of photovoltaic power generation system. It converts the direct current generated by the photovoltaic panel into alternating current and also can be used to optimize self-consumption or feed into the public grid. The first figure shows the typical application scenario of 40 kW-125 kW inverter and the second figure shows the typical application scenario of 136 kW-150 kW inverter.

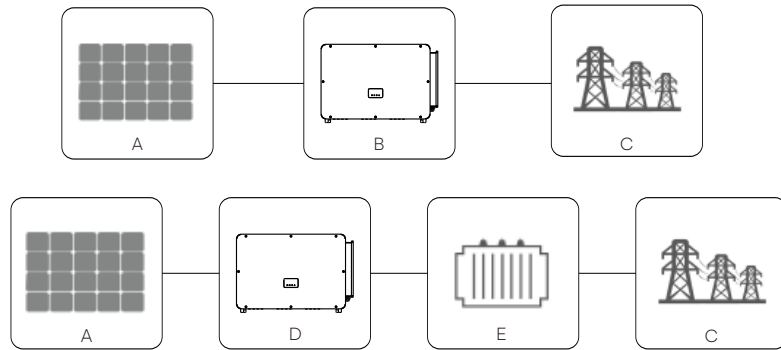

NO.	Defination
A	Photovoltaic string
B	X3-FORTH 40 kW-125 kW inverter
C	Power grid
D	X3-FORTH 136 kW-150 kW inverter
E	Transformer

Warning!
 The inverter shall not be connected to the PV string requiring positive grounding or negative grounding. Do not connect local load between inverter and AC side circuit breaker!

The power grid supported by the inverter are TN-S, TN-C, TN-C-S, TT and IT.

40 kW-70 kW inverters are connected to 127 V / 220 V three-phase four wire power grid and 80 kW-125 kW inverters are connected to 380V / 400V three-phase four wire power grid, which can be connected with N line (or not), as shown in Figure 1;

136 kW and 150 kW models are directly connected to the medium voltage power grid through 500 V or 540 V transformer without N line access, as shown in Figure 2;

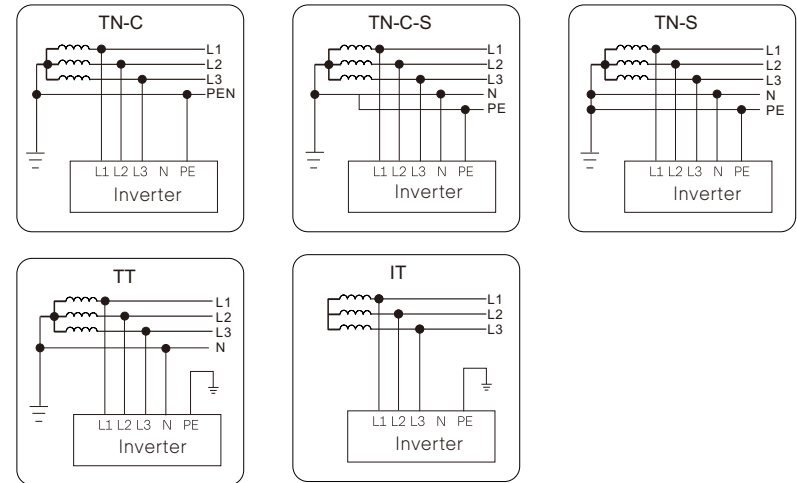

Figure 1

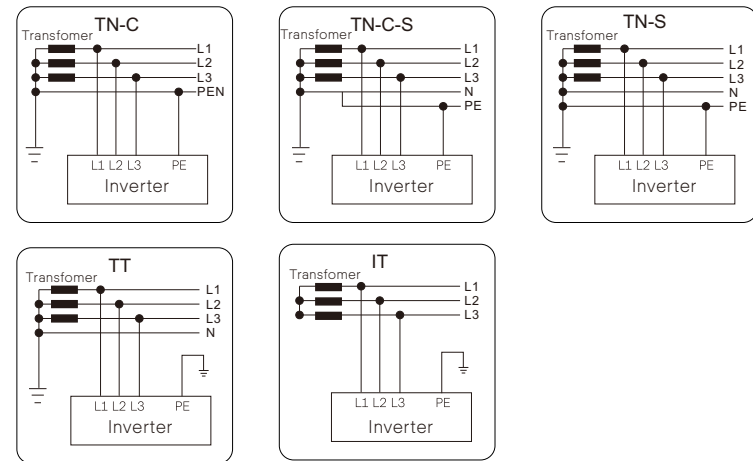

Figure 2

3.2 Basic Features

Thanks for your purchasing with this series inverter. Basic features are as follows:

- 2 Strings per MPP tracker, maximum 12 MPP trackers
- Max DC input current 16 A per string, Max DC input current 32 A for each MPP tracker, supporting double side arrays
- Max 150% oversizing DC input power; Max. 110% apparent AC output power
- Remote error diagnoses and firmware upgrade dispatching grid power remotely; reactive power compensating during night
- Smart air cooling, adjustable fan speed
- Current monitoring on each MPP tracker, smart I-V curve scan
- Support electric ARC monitoring (optional), AC output terminal temperature monitoring
- Safety & Reliability: transformerless design with software and hardware protection.
- Power factor regulation.
- Friendly HMI.
 - LED status indications.
 - LCD display technical data, Human-machine interaction through press key.
 - Dry contact communication interface.
 - PC remote control.
 - Remote upgrade and upgrade through USB interface.
 - RS485/PLC communication interfaces available (Optional): WI-FI/4G available
 - Energy conservation.

3.3 Overview of the Inverter

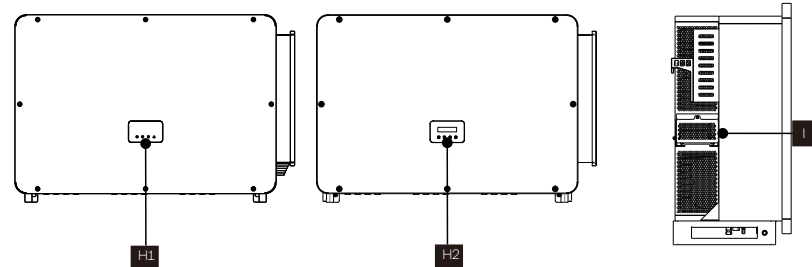
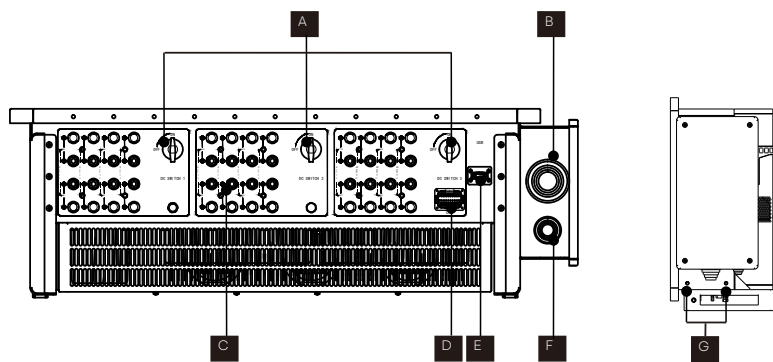



Item	Description
A	DC Switch
B	AC Connector
C	DC Connector
D	RS 485 / Meter / DRM connector (optional)
E	WiFi / LAN / 4G dongle connector (optional)
F	Ground Connector
G	Ground Screw
H1	LED indicator
H2	LCD (Optional)
I	Fan support (cooling fan inside)

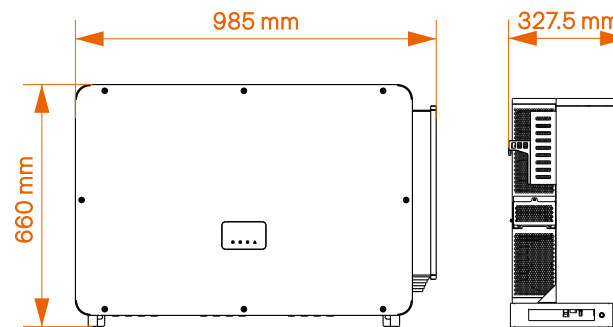

WARNING!
Only authorized personnel is allowed to set the connection.

3.4 Dimension





NOTE!
The dimension of the inverter with LCD is same as the inverter with LED.

3.5 Principle Description

The inverter is equipped with multi-channel MPPT for DC input to ensure maximum power even under different photovoltaic input conditions. The inverter unit converts DC into AC that meets the requirements of the power grid and feeds it into the power grid. The lightning arrester at AC / DC side can realize the function of surge protection. The principle design of inverter is shown in the figure below:

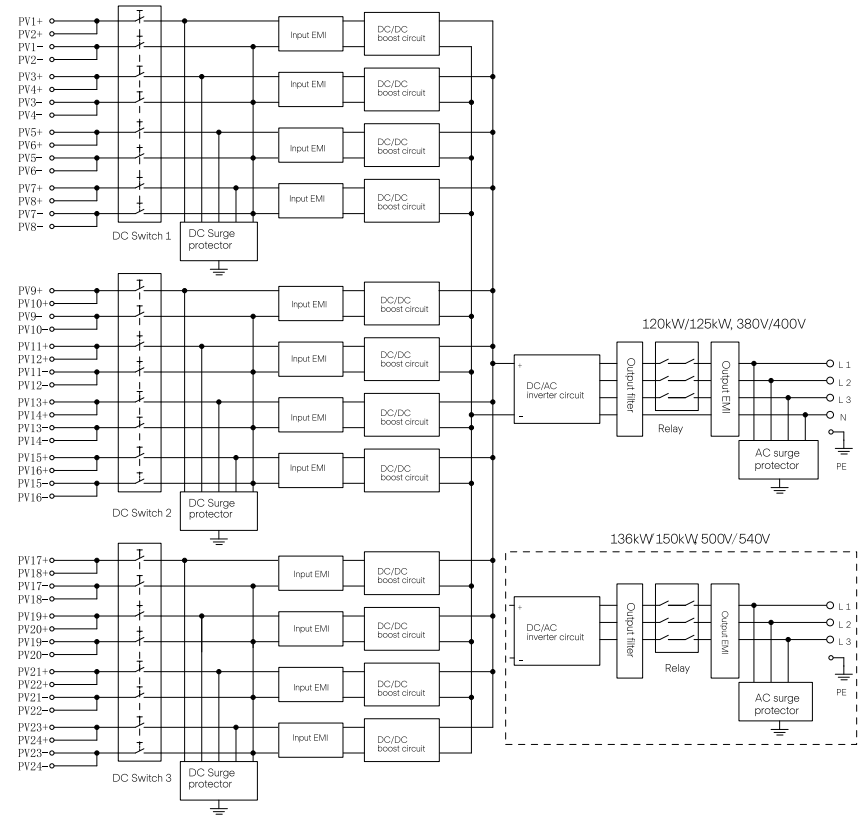
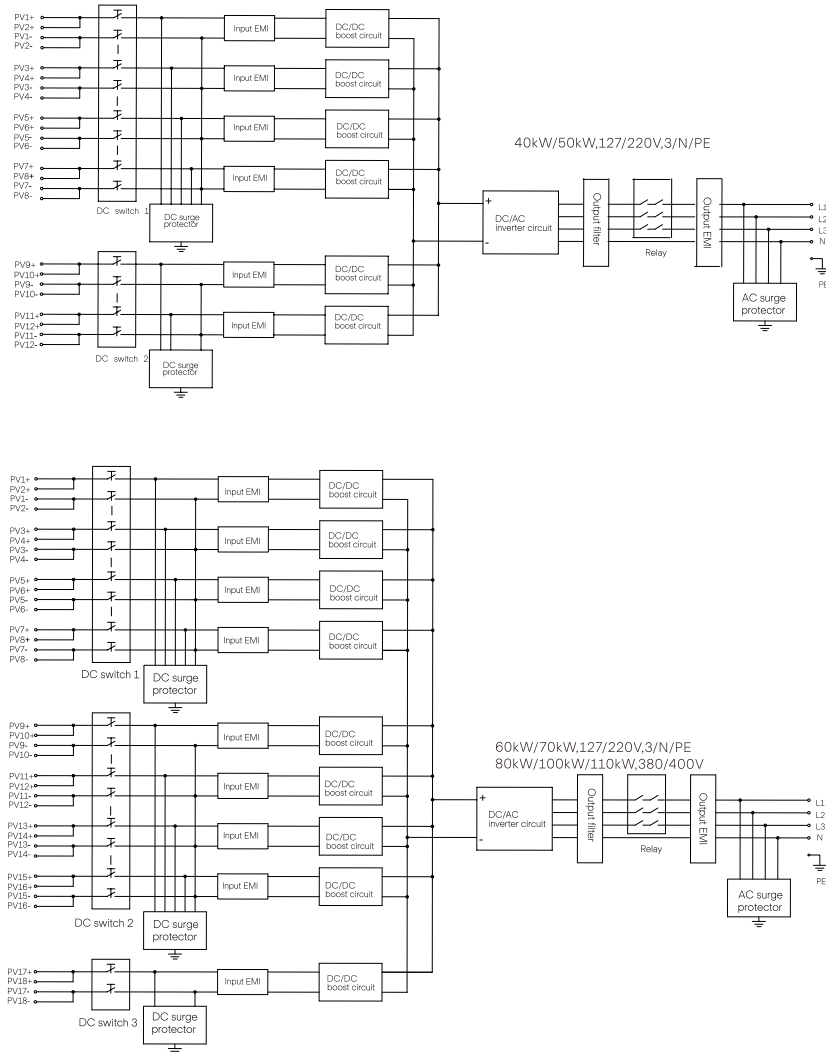

4. Technical Data

4.1 DC Input

➤ DC input of 40kW-70kW inverter

Model	X3-FTH-40K-LV	X3-FTH-50K-LV	X3-FTH-60K-LV	X3-FTH-70K-LV
Max. DC power [kW]	60	75	90	105
Max. DC voltage [V]	800	800	800	800
Rated DC voltage [V]	360	360	360	360
Start input voltage [V]	200	200	200	200
MPPT voltage range@full load [V]	180-650	180-650	180-650	180-650
Max. DC current [A] / MPPT	32	32	32	32
Max. short circuit current [A] / MPPT	46	46	46	46
No. of MPP trackers	6	6	9	9
Strings of MPP tracker	12	12	18	18

➤ DC input of 80kW-150kW inverter

Model	X3-FTH-80K	X3-FTH-100K	X3-FTH-110K	X3-FTH-120K	X3-FTH-125K	X3-FTH-136K-MV	X3-FTH-150K-MV
Max. DC power [kW]	120	150	165	180	188	204	225
Max. DC voltage [V]	1100	1100	1100	1100	1100	1100	1100
Rated DC voltage [V]	600	600	600	600	600	730/785	730/785
Start input voltage [V]	200	200	200	200	200	200	200
MPPT voltage range@full load [V]	500-800	500-800	500-800	500-800	500-800	567-800	625-800
Max. DC current [A] / MPPT	32	32	32	32	32	32	32
Max. short circuit current [A] / MPPT	46	46	46	46	46	46	46
No. of MPP trackers	9	9	9	12	12	12	12
Strings of MPP tracker	18	18	18	24	24	24	24

4.2 AC Output

➤ AC output of 40kW-70kW inverter

Model	X3-FTH-40K-LV	X3-FTH-50K-LV	X3-FTH-60K-LV	X3-FTH-70K-LV
Rated apparent AC power [kVA]	40	50	60	70
Rated AC current [A]	105	131.3	157.5	183.7
Max. active power [kW]	44	55	66	70
Max. apparent AC power [kVA]	44	55	66	70
Max. AC current [A]	115.5	144.5	173.5	183.7
Nominal AC voltage [V]	127 / 220, 3 / N / PE			
Nominal AC frequency [Hz]	50/60			
Frequency range of power grid [Hz]	50 (±5)/60 (±5)			
Total harmonic distortion (THDi)	<3% (Rated power)			
DC component of AC current	<0.5% _i			
Power factor	>0.99 (Rated power)			
Power factor range	0.8 leading-0.8 lagging			

➤ AC output of 80kW-150kW inverter

Model	X3-FTH-80K	X3-FTH-100K	X3-FTH-110K	X3-FTH-120K	X3-FTH-125K	X3-FTH-136K-MV	X3-FTH-150K-MV
Rated apparent AC power [kVA]	80	100	110	120	125	136	150
Rated AC current [A]	121.3/116	151.6/145	166.7/159.5	181.9/174	189.4/181.2	157.1/145.4	173.2/160.4
Max. active power [kW]	88	110	121	132	132	149.6	165
Max. apparent AC power [kVA]	88	110	121	132	132	149.6	165
Max. AC current [A]	133.4/127.6	166.7/159.5	183.4/175.4	200/191.3	200/191.3	172.8/160	190.6/176.5
Nominal AC voltage [V]	3 × 230 / 400, 3W+(N)+PE					500/540,3P3W+PE	
Grid voltage range [V]	176 - 276 / 304 - 480 *					-	-
Nominal AC frequency [Hz]	50/60						
Frequency range of power grid [Hz]	50 (±5)/60 (±5)						
Total harmonic distortion (THDi)	<3% (Rated power)						
DC component of AC current	<0.5% _i						
Power factor	>0.99 (Rated power)						
Power factor range	0.8 leading-0.8 lagging						

4.3 Efficiency, Safety and Protection

➤ Efficiency, safety and protection of 40kW-70kW inverter

Model	X3-FTH-40K-LV	X3-FTH-50K-LV	X3-FTH-60K-LV	X3-FTH-70K-LV
Max. efficiency	98.0%	98.0%	98.0%	98.0%
Safety & Protection				
DC Switch			YES	
DC isolation protection			YES	
Monitoring ground fault protection			YES	
Grid protection			YES	
Over current protection			YES	
Over load protection			YES	
Anti-Islanding protection			YES	
DC Surge protection			Type II	
AC Surge protection			Type II	
Residual current detection			YES	
DC injection monitoring			YES	
Over heat protection			YES	

➤ Efficiency, safety and protection of 80kW-150kW inverter

Model	X3-FTH-80K	X3-FTH-100K	X3-FTH-110K	X3-FTH-120K	X3-FTH-125K	X3-FTH-136K-MV	X3-FTH-150K-MV
Max. efficiency	98.6%	98.6%	98.6%	98.6%	98.6%	99.0%	99.0%
Safety & Protection							
DC Switch					YES		
DC isolation protection					YES		
Monitoring ground fault protection					YES		
Grid protection					YES		
Over current protection					YES		
Over load protection					YES		
Anti-Islanding protection					YES		
DC Surge protection					Type II		
AC Surge protection					Type II		
Residual current detection					YES		
DC injection monitoring					YES		
Over heat protection					YES		

4.4 General Data

➤ General data of 40kW-70kW inverter

Model	X3-FTH-40K-LV	X3-FTH-50K-LV	X3-FTH-60K-LV	X3-FTH-70K-LV
Self-consumption (night)	<10 W			
Isolation type	Non-isolated			
Protective Class	IP66			
Operating temperature range	-25°C~+60°C (derating at +45°C)			
Operation relative humidity	0-100% RH			
Cooling	Smart cooling			
Altitude	4000 m (Derating at 3000)			
Dimension [W/H/D] [mm]	985 × 660 × 327.5			
Weight [kg]	80.5		83	
Display	LED indicator × 4, LCD (Optional)			
Communication interfaces	RS485/PLC (Optional)/External WiFi/4G modular (Optional)/USB			
Safety	IEC/EN 62109-1; IEC/EN 62109-2; NB/T 32004			
EMC	IEC/EN 61000; NB/T 32004			
Certification	AS/NZS 4777.2; NB/T 32004; IEC 61727; IEC 62116; VDE4110; VDE4105; EN50549; NRS097; G99; RD1699; PPDS2020; CEI0-21; CEI0-16; VFR 2019			
Standard warranty [year]	5years/10years (Optional)			

➤ General data of 80kW-150kW inverter

Model	X3-FTH-80K	X3-FTH-100K	X3-FTH-110K	X3-FTH-120K	X3-FTH-125K	X3-FTH-136K-MV	X3-FTH-150K-MV
Self-consumption (night)	<10 W						
Isolation type	Non-isolated						
Protective Class	IP66						
Operating temperature range	-25°C~+60°C (derating at +45°C)						
Operation relative humidity	0-100%RH						
Cooling	Forced air cooling						
Altitude	4000 m (Derating above 3000 m)						
Dimension [W/H/D] [mm]	985 × 660 × 327.5						
Weight [kg]	83					87	
Display	LED indicator × 4, LCD (Optional)						
Communication interfaces	RS485/External WiFi (Optional) /4G module (Optional)/USB						
Safety	IEC/EN 62109-1 ; IEC/EN 62109-2 ; NB/T 32004						
EMC	IEC/EN 61000 ; NB/T 32004						
Certification	AS/NZS 4777.2; NB/T 32004; IEC 61727; IEC 62116; VDE4110; VDE4105; EN50549; NRS097; G99; RD1699; PPDS2020; CEI0-21; CEI0-16; VFR 2019						

Note: At an ambient temperature of 25°C, the maximum short-circuit current of 46A allows 1 MPPT to be short-circuited for half an hour. The maximum short-circuit current of 40A allows 3 MPPTs to be short-circuited for 2 hours. AC voltage and frequency ranges may vary depending on the specific state grid.

5. Mechanical Installation

5.1 Installation Precaution



DANGER!

Before installation, make sure there is no electrical connection.
Before drilling holes on the wall, make sure the layout of the water pipes and cables inside the wall is clearly known to avoid any danger.



CAUTION!

Personal injury and machine damage may be caused by improper movement of the inverter.
Please strictly comply with the instructions of this manual when moving and installing the inverter.

5.2 Selection for the Installation Position

The installation location selected for the inverter is quite critical in the aspect of the guarantee of machine safety, service life and performance.

- The inverter has the IP66 ingress protection, which allows it to be installed outside the door.
- The installation position shall be convenient for wiring connection, operation and maintenance.

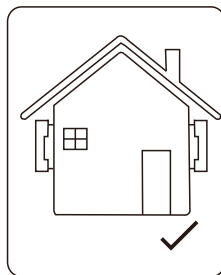

5.2.1 Installation Environment Required

The installation position shall be well ventilated.

Make sure the installation site meets the following conditions:

Not be exposed to glare.

Not in areas where highly flammable materials are stored.

Not in potential explosive areas.

Not in the cool air directly.

Not near the television antenna or antenna cable.

Not higher than altitude of about 4000m above sea level.

Not in environment of precipitation or humidity (0-100%) .

Be sure the ventilation is good enough.

The ambient temperature in the range of -25°C to +60°C.

The slope of the wall should be within ±5°.

Avoid direct sunlight, rain exposure, snow laying up during installing and operating.

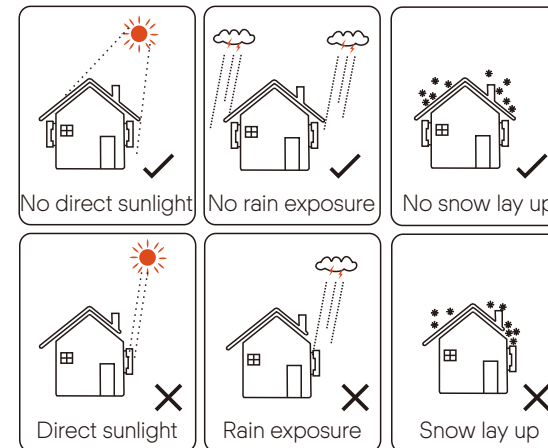

5.2.2 Installation carrier required

The wall or stand hanging the inverter should meet conditions below:

- 1) Solid brick / concrete, or strength equivalent mounting surface;
- 2) Inverter must be supported or strengthened if the strength of wall/stand isn't enough. (such as wooden wall, the wall covered by thick layer of decoration)

5.2.3 Installation Angle Required

The inclination angle of the installation shall not be greater than 5° and can not be tilted forward, inverted, excessive back tilted or side tilted.
The inverter shall be installed more than 500 mm above the ground.

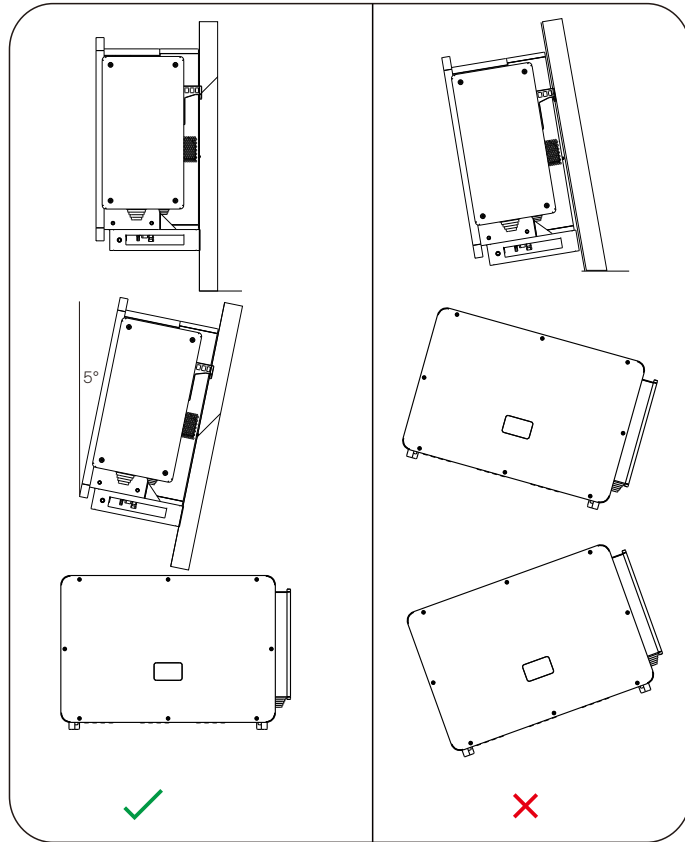

5.2.4 Installation Space Required

To ensure good heat dissipation and convenient disassembly, the minimum clearance around the inverter shall not be less than the following values, as shown in the following figure.

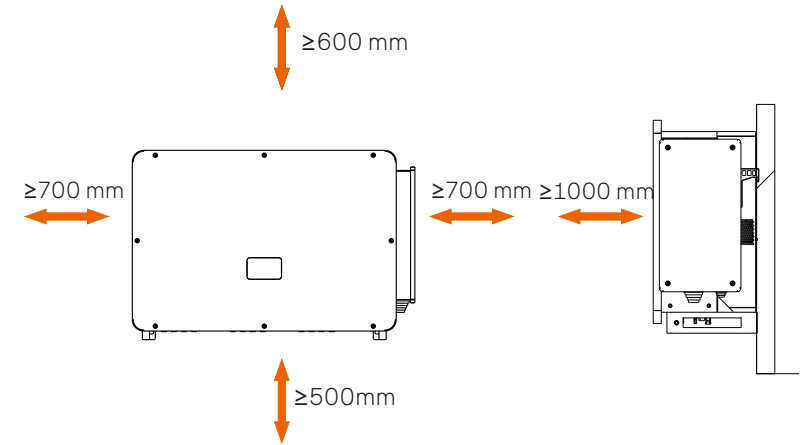

For multi-inverter installation, please reserve the space of 1200 mm at least between each left and right inverter and at least 500 mm between each upper and lower inverter.

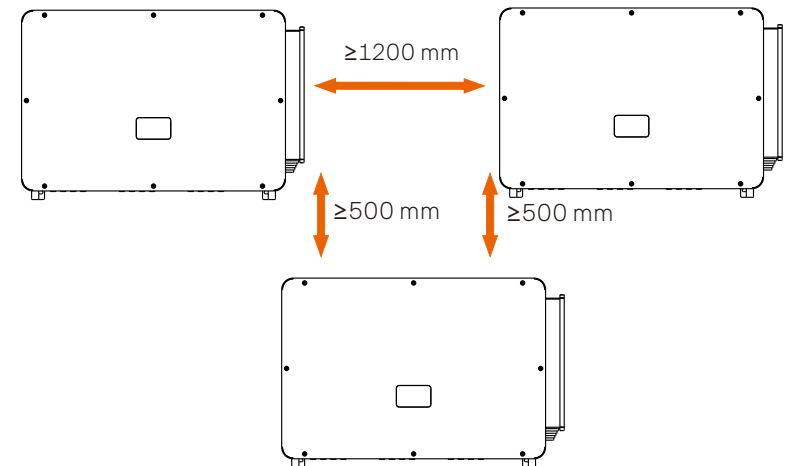

5.3 Tools Preparation for Installation and Connection

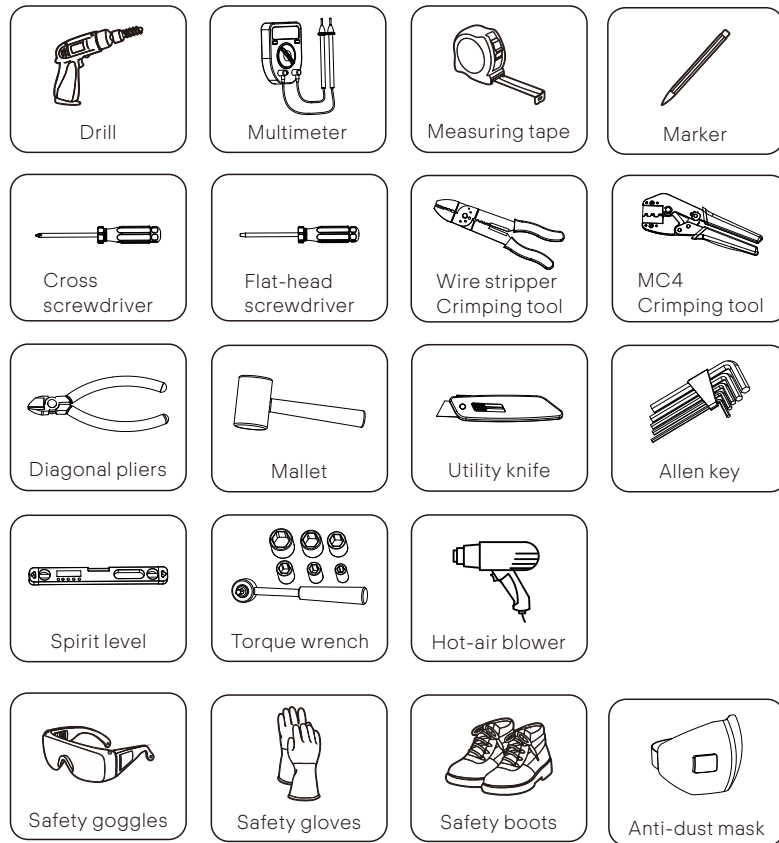

5.4 Check for Transport Damages

Make sure the inverter is intact during transportation. If there are some visible damages, such as cracks, please contact your dealer immediately.

5.5 Packing Lists

Open the package and fetch out the product, check the accessories at first. The packing list shows as below.

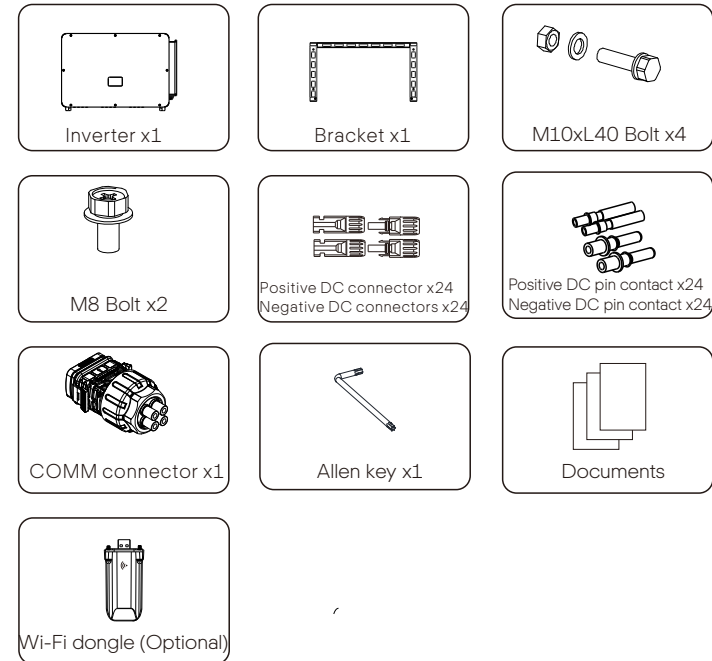

* For the optional accessories, please be subject to the actual delivery.

5.6 Installation steps

5.6.1 Installation steps of mounting the inverter on the wall

➤ Step 1: Fix the bracket on the wall

- a. Find out the bracket and M8 bolts from the accessory box as below: And prepare M10x80 iron expansion combination in advance. Please kindly note that M10x80 screws are not in the accessory box. Please prepare them in advance.

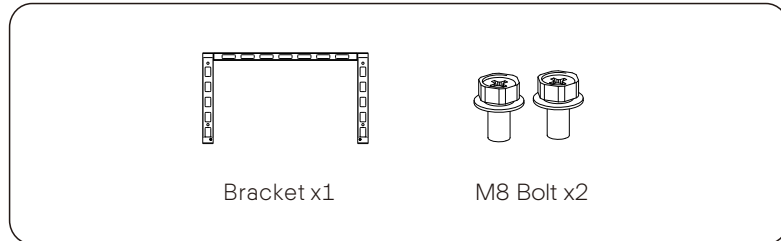

- b. Use the bracket as a template for marking the positions of drilling holes on the wall with spirit level and marker.
 c. Use $\Phi 13$ drill to drill holes in accordance with the mark. The depth of the holes shall be at least 65 mm.
 d. Insert the expansion screws into the holes, hang the bracket on the screw and fix it with nut.

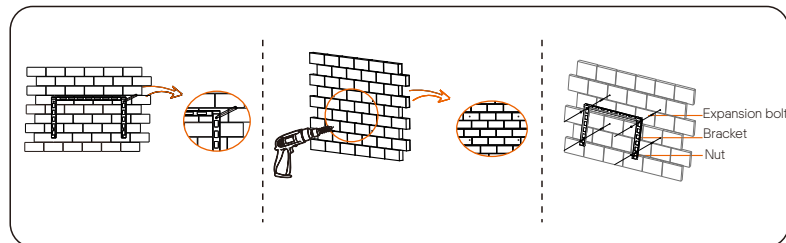

➤ Step 2: Hang the inverter on the bracket

- a. Lift up the inverter. Two methods are available for your choice. Method 1: Four installers directly hold the inverter on the two sides and lift it up. Method 2: Install two lifting rings on the two sides of inverter and lift it up.

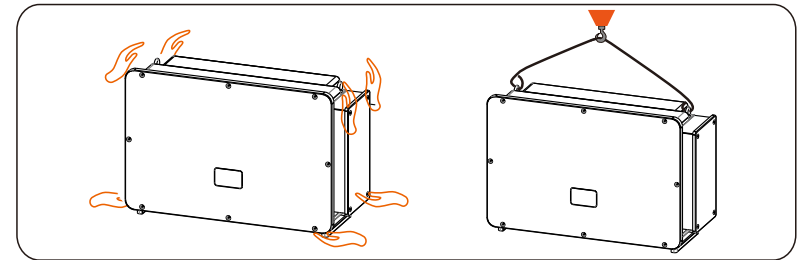

- b. Hang the inverter on the bracket and secure it on the bracket with M8 bolts. (Torque: 7.0-8.5 N·m)

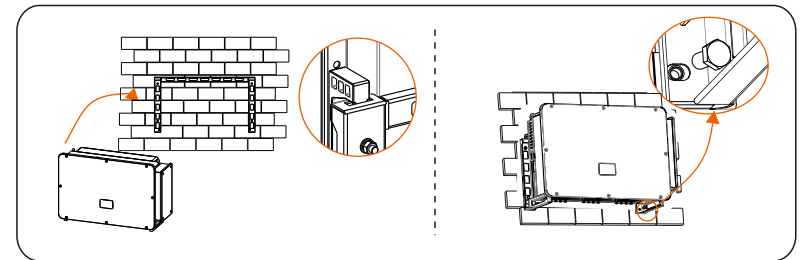

5.6.2 Installation steps of mounting inverter on the stand

➤ Step 1: Fix the bracket on the stand

- a. Find out the four M10x40 bolt combination, bracket and two M8 bolts from the accessory box as below:

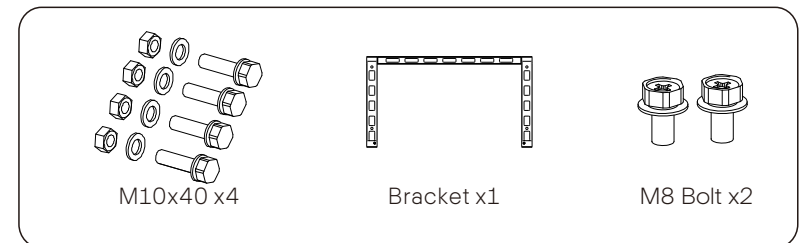

- b. Use the bracket as a template for marking the position of drilling holes on the stand with a spirit level and marker.
- c. Use $\Phi 12$ drill to drill holes in accordance with the mark.
- d. Pre-install the bracket on the stand and screw in the M10X40 screws.

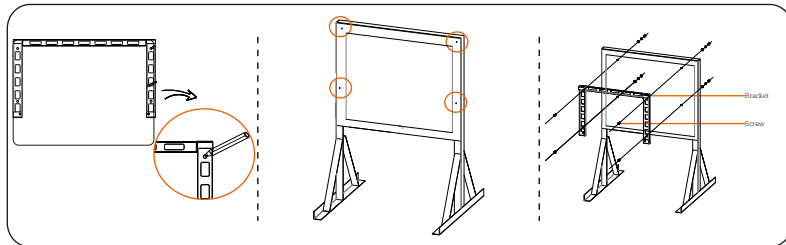

➤ Step 2: Hang the inverter on the bracket

- a. Lift up the inverter. Two methods are available for your choice.
Method 1: Four installers directly hold the inverter on the two sides and lift it up.
Method 2: Install two lifting rings on the two sides of inverter and lift it up.

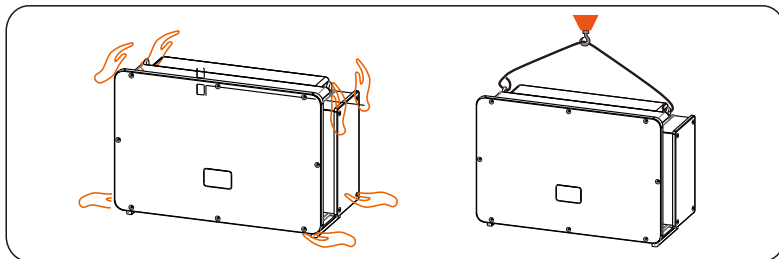

- b. Hang the inverter on the bracket and secure it with M8 bolts. (Torque: 7.0-8.5 N·m)

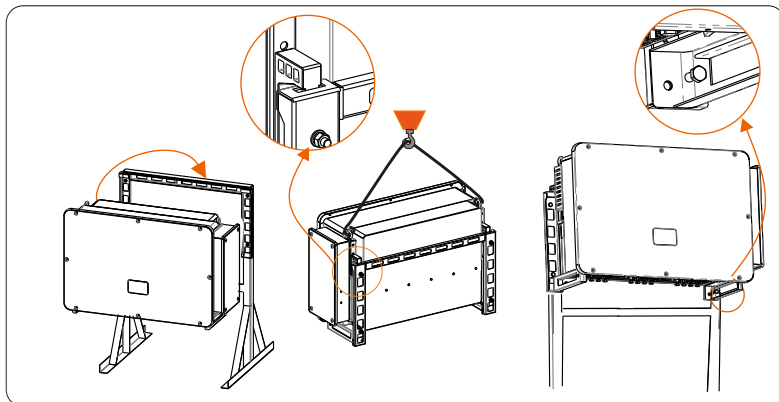

6. Electrical connection

6.1 Grounding connection

The uncharged metal parts in the photovoltaic power generation system, including the photovoltaic substrate bracket and the metal shell of the inverter, should be reliably grounded. The grounding part of multiple inverters and photovoltaic array shall be connected to the same grounding bus to establish reliable equipotential connection.

➤ Step 1: Make the grounding cable

- a. Select OT copper terminal and 35-70 mm² yellow and green conductor with proper length by diagonal pliers. Use wire stripper to strip the insulation layer of the conductor end. The stripped length shall be as shown below:
- b. Tighten the stripped end and pull the heat-shrink tubing over the grounding cable. The heat-shrink tubing must be at below cable section.

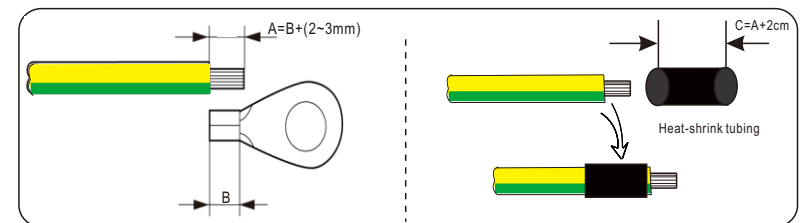

- c. Insert the stripped section into the OT copper terminal and crimp with crimping tool.
- d. Pull the heat-shrink tubing over the stripped section of OT terminal and use hot-air blower to shrink it so that it can be in firm contact with OT terminal.

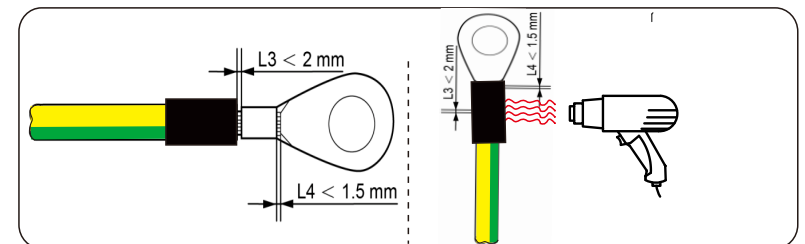

- Step 2: Connect the grounding cable to the inverter.

Connect the grounding cable to the inverter and fix it with torque 7.0-8.5 N·m.

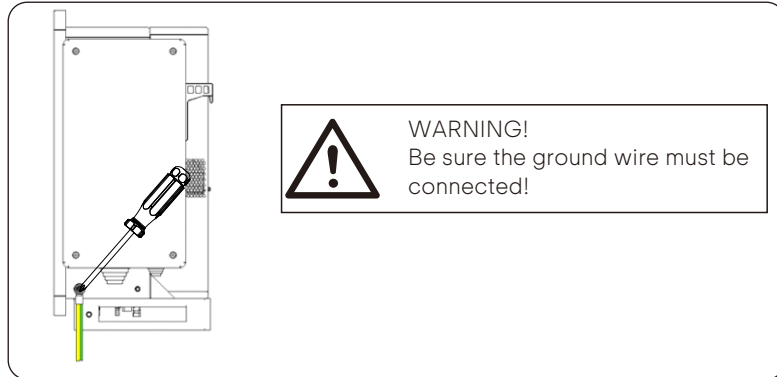

6.2 PV String Connection

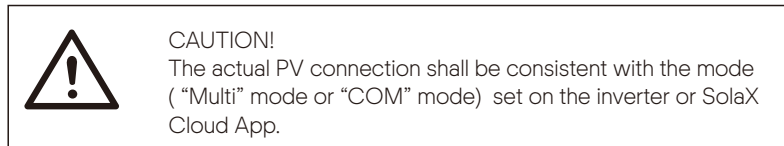
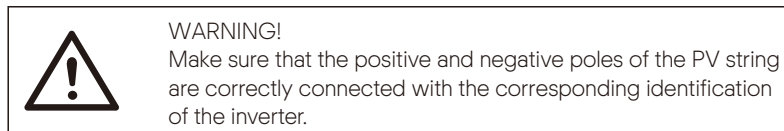
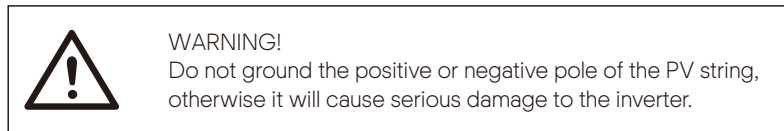
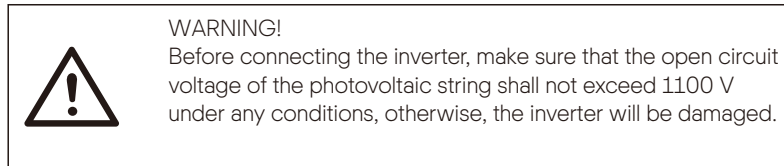

- Step 1: Make the PV cable

- Find out the positive/negative x24 DC connector and x24 positive/negative DC pin contact from accessory box.

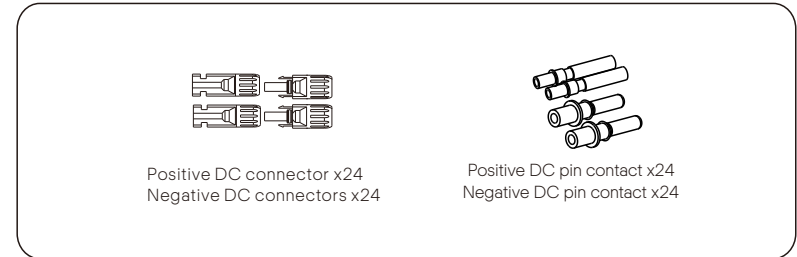

- Turn off the DC switch and prepare a 4-6 mm² PV cable. Use wire stripper to strip 6 mm insulation layer of the PV cable end.

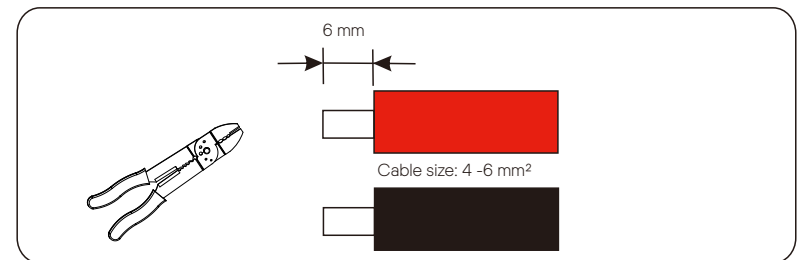

- Tighten the stripped section and insert it into the PV pin contact. And use terminals press clamp to clamp it so that the stripped section of PV cable is in firm contact with PV pin contact.
- Insert the PV cable through fastening head and plug (male and female) and force the male or female plug to the cable. You will hear “Click” which indicates the connection is completed. Then tighten the fastening head.

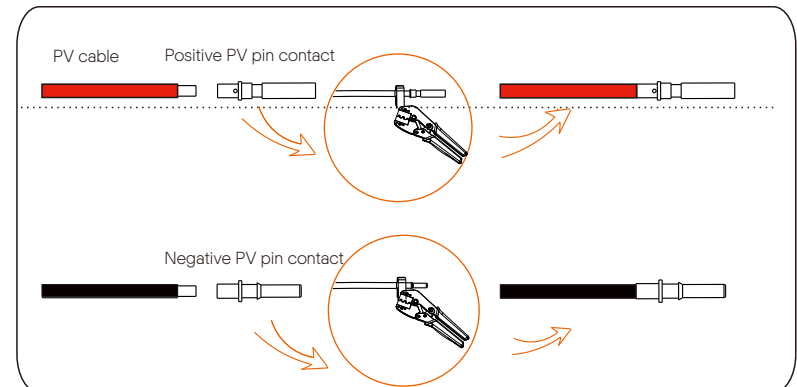

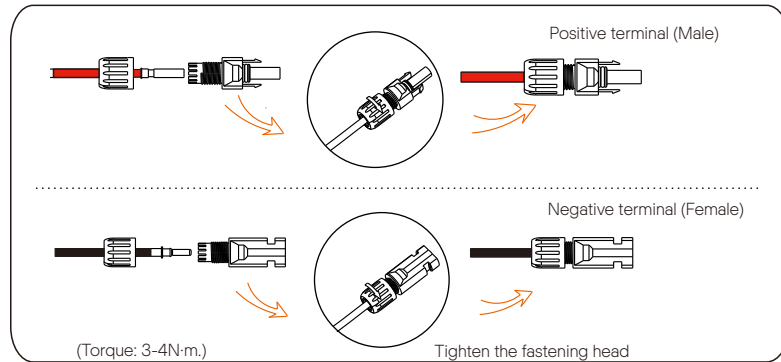

➤ Step 2: Measure the voltage of DC input

Use a multimeter to measure the PV voltage of DC input, verify the polarity of DC input cable, and ensure that the voltage for each string is within the range of inverter.

➤ Step 3: Connect the PV cable to the inverter

Connect the PV cable to the corresponding PV port on the inverter, shown as below:

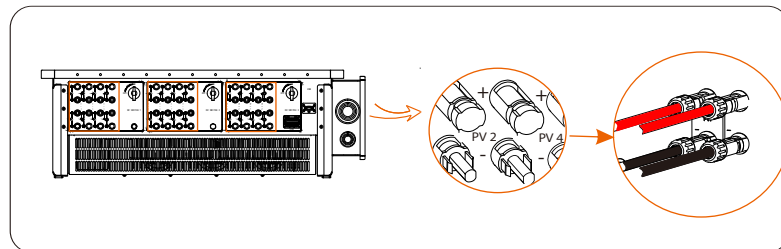

WARNING!
When the DC cable is reversely connected or the inverter fails to work normally, it is forbidden to turn off the DC switch directly or pull out the DC string.

The correct operation is as follows:

- Use clamp current meter to measure DC string current.
- If it is greater than 0.5 A, please wait until the current is less than 0.5 A.
- Only when the current is less than 0.5 A, can the DC power be cut off and the DC string be pulled out.

The inverter damage caused by improper operation will not be included in the warranty.

Requirements for photovoltaic modules connecting to the same circuit:

- All PV modules shall be of the same specification.
- All PV modules have the same tilt angle and orientation.
- The open circuit voltage of the PV string shall not exceed 1100 V at the coldest expected temperature in time

WARNING!
Electric shock!

Do not touch live DC wires. When photovoltaic modules are exposed to light, high voltage will occur, which will lead to the risk of electric shock, resulting in death due to contact with DC conductor.

6.3 Grid Connection

WARNING!
Ensure electrical connection design meets local national and local standards.

WARNING!
The PE wire (ground wire) of the inverter must be reliably grounded.

WARNING!
Disconnect the circuit breaker or fuse of inverter and grid connection access point.

Note:

- It is recommended to add circuit breaker or fuse at AC side, whose specification is more than 1.25 times of rated AC output current.
- 70~240 mm² copper wire is recommended. If aluminum wire is needed, please consult the inverter manufacturer.
- Use copper terminal for copper wire, use copper aluminum terminal for aluminum wire, not aluminum terminal directly.



NOTE!
40 kW-70 kW / 80 kW-120 kW inverter adopts 4-pin AC terminal;
136kW/150kW inverter adopts 3-pin AC terminal.



NOTE!
The "Delta Grid" in "Setting"- "Grid Protection"- "FunctionChoose" is set as "Enable" in default. In this condition, the Neutral wire is not required to be connected. Please set "Delta Grid" to "Disable" before connecting the Neutral wire for 40 kW-70 kW / 80 kW-125 kW inverter.

➤ Step 1: Make the AC cable

- Select the appropriate OT terminal and black, red and yellow and green cable with proper length by wire cutter, and use wire stripper to strip the insulation layer of the AC cable end. The stripped insulation layer shall be 2-3 mm longer than "D" part of OT terminal.

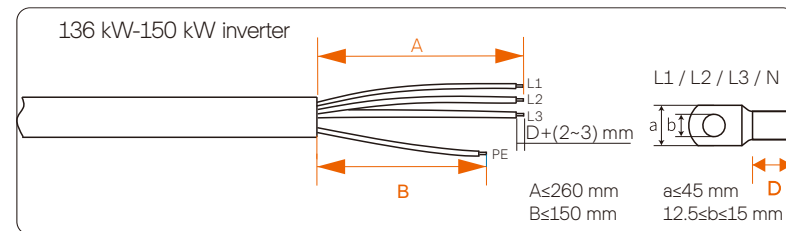
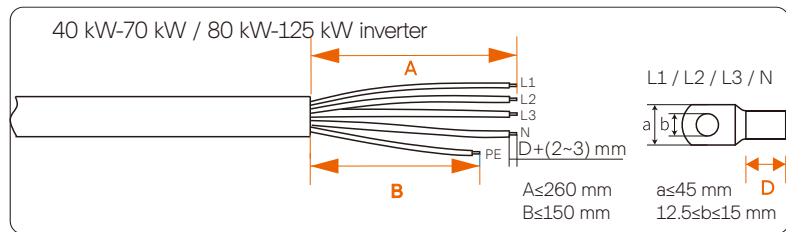

- Pull the heat-shrink tubing over AC cable.
- Insert the stripped section into OT terminal and crimp with crimping tool and pull the heat-shrink tubing over the crimped section of OT terminal. Then use hot air blower to shrink it so that they are in firm contact with OT terminal.

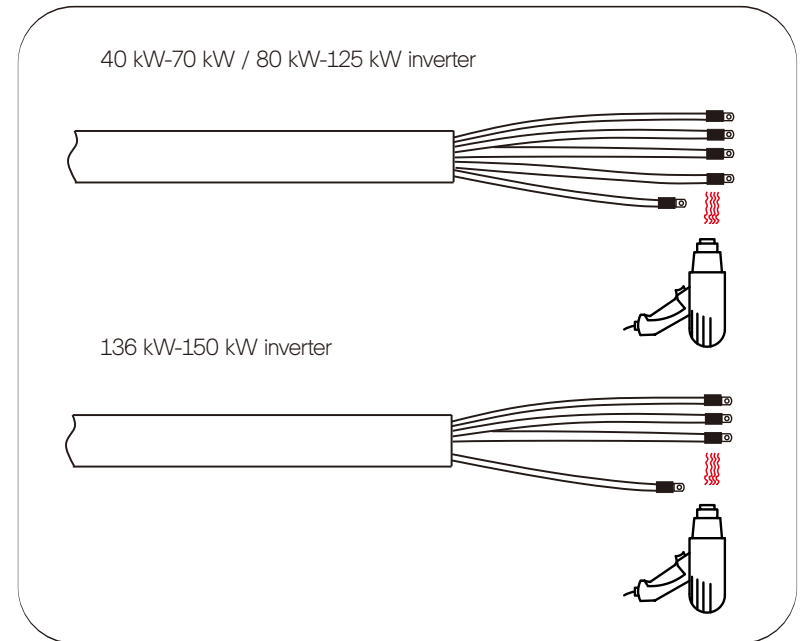
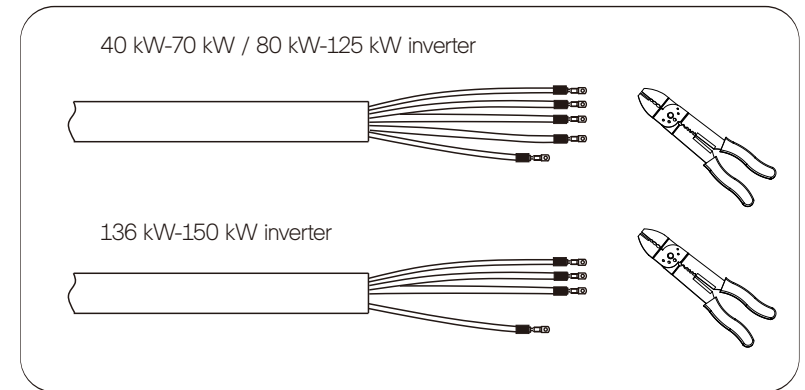

d. Open the cover of the wiring box.

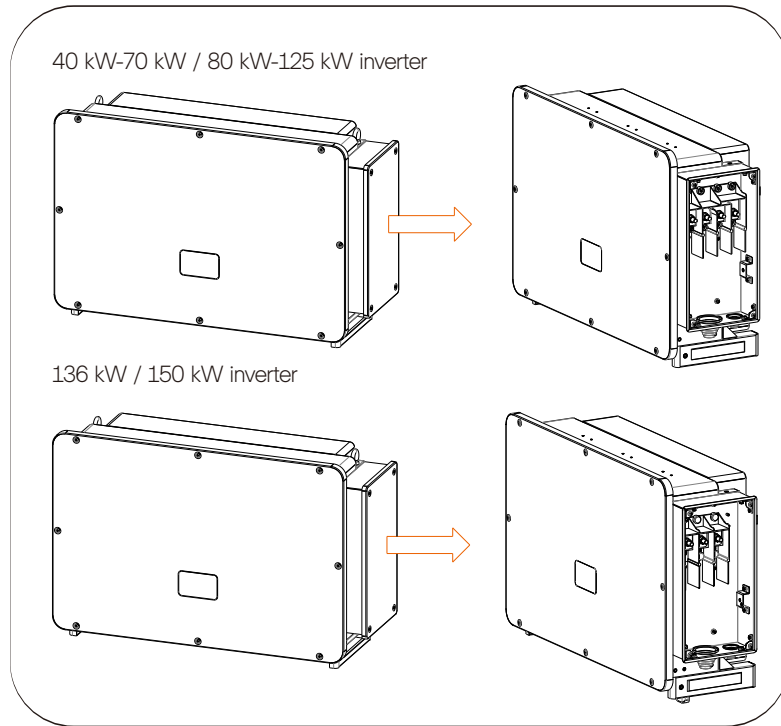

➤ Step 2: Connect the AC cable to the inverter

a. Use utility knife to cut out the pagoda type protection ring in accordance with the whole cable size, route the AC cable through the pagoda protection ring, and connect it to the AC terminals L1, L2, L3 and N in turn, and tighten it with torque wrench (with the torque of 25-30 N·m).

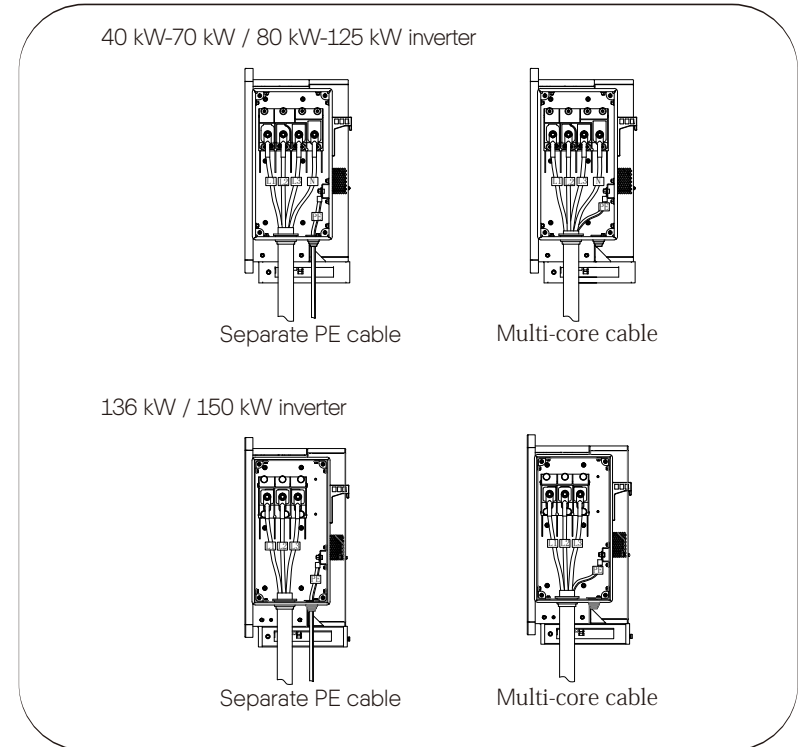

b. Re-install the cover of wiring box and tighten it with screws (with the torque of 5-7 N·m).

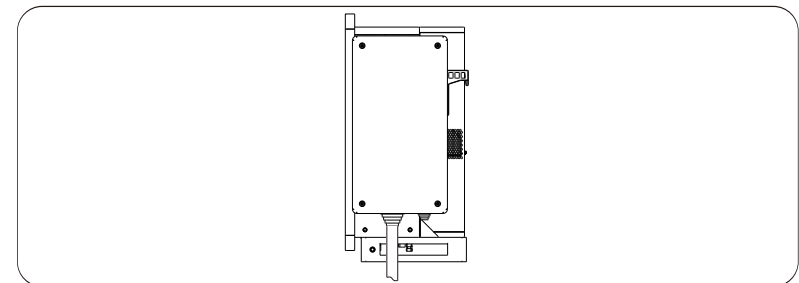

6.4 Communication Connection

6.4.1 Communication signal definition

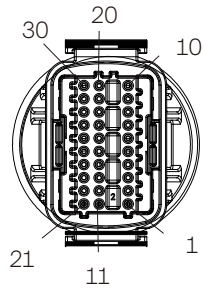

Port	Pin	Definition	Remark
RS-485-1	1	RS485A IN+	Inverter RS485 networking or connect the data collector
	2	RS485B IN-	
	3	RS485 IN-GND	
	4	RS485A OUT+	
	5	RS485B OUT-	
	6	RS485 OUT-GND	
RS-485-2	7	RS485A METER	Connect the RS485 meter or other devices
	8	RS485B METER	
	9	V+5V	
	10	COM_GND	
DRM	11	DRM1/5	Reserved for DRM
	12	DRM2/6	
	13	DRM3/7	
	14	DRM4/8	
	15	RG/0	
	16	CL/0	
DI	21	Digital IN+	Input digital signal
	22	Digital IN-	
DO	29	Digital OUT+	Output digital signal
	30	Digital OUT-	

6.4.2 Connection steps of communication cable

a. Find out the communication terminal from the accessory box and disassemble it into the following parts.

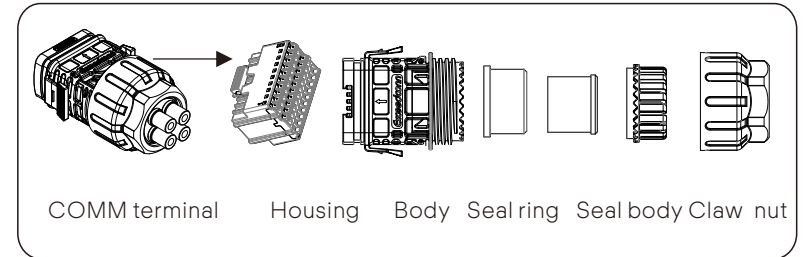

b. Select 0.5-0.75 mm² conductor and use wire stripper to strip 12-14 mm insulation layer of the cable end and insert the insulated cord end terminal to the cable end. (ENY0512 nylon terminal for 0.5 mm²/22 AWG conductor; ENY7512 nylon terminal for 0.75 mm²/20 AWG conductor)

c. Use crimping tool to make the terminal in firm contact with the cable end.

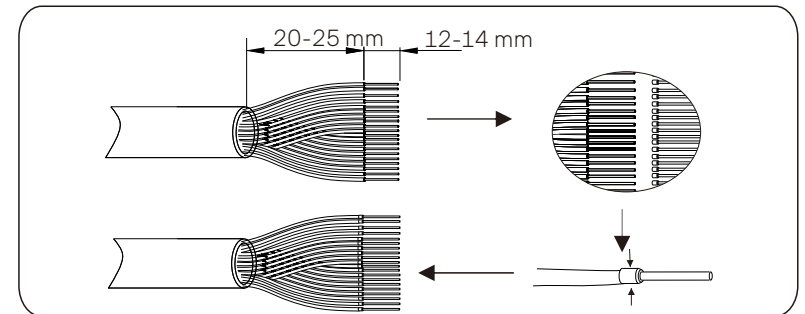

d. Set the nut, claw, seal body, seal ring and body on the communication cable in turn.

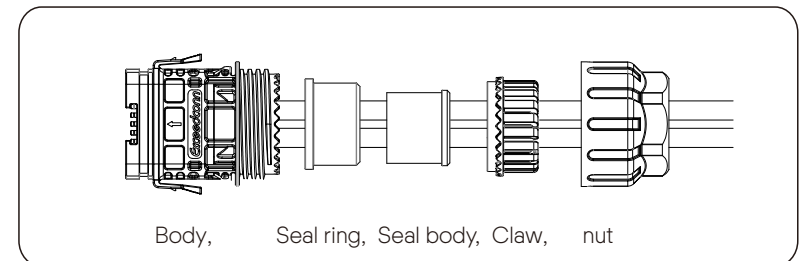

- e. Insert the tube type terminal into the housing according to the label on it. Push the terminal-inserted housing into the body. There will be a slight sound of "Click", which indicates the connection is completed.

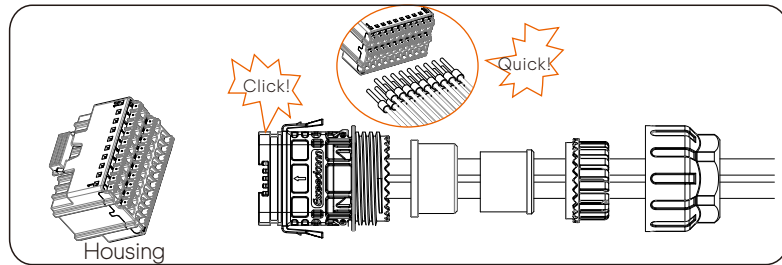

- f. Push the seal body into seal ring, then push the claw.
- g. Clockwise tighten the nut with torque 8+/-2 N·m.
- h. Keep the buttons on both sides pressed and connect it to the COM port of the inverter. There will be a slight sound of "Click" if it is correctly connected.

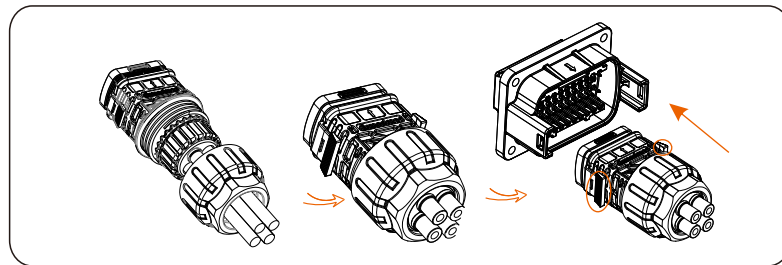

6.4.3 Release steps of communication cable

For releasing the communication cable, please keep the buttons on the two sides pressed and pull out the cable to make it unlocked.

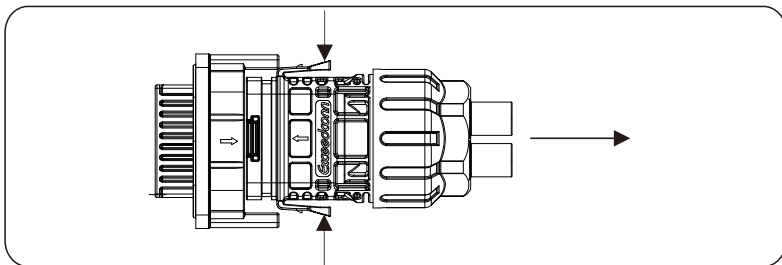

6.5 PLC Box Connection (Optional)

The inverter supports to be connected with PLC Box. With PLC Box, RS485 cable is not required for communication. Purchase the product from supplier if needed. Refer to PLC Box Quick Installation Guide for detailed installation and connection of PLC Box.

For monitoring on SolaX Cloud, Datahub shall be installed to communicate with PLC Box. The communication between PLC Box and inverters is power line, and from PLC Box to Datahub is RS485.

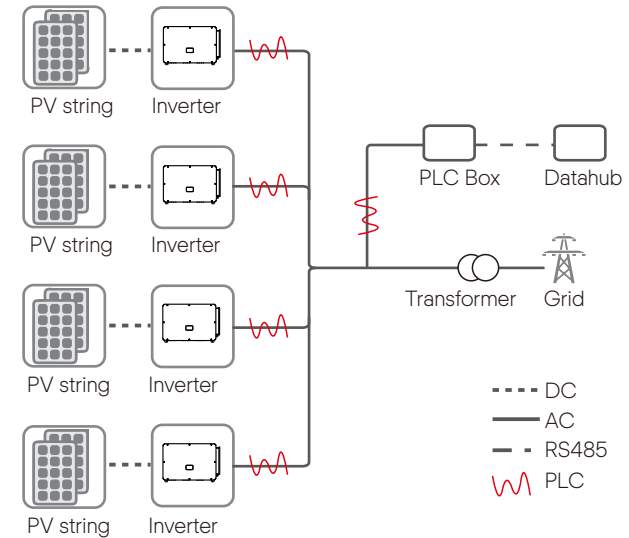

6.6 Monitoring Connection

Monitoring Cloud is an application that can communicate with the inverter via Wi-Fi/LAN/4G. It can realize alarm query, parameter configuration, daily maintenance and other functions. This is a convenient maintenance platform.

Plug Dongle into "USB" port at the bottom of the inverter. After the DC side or AC side is powered on, the APP and inverter can be connected. Please refer to the corresponding manual for details.

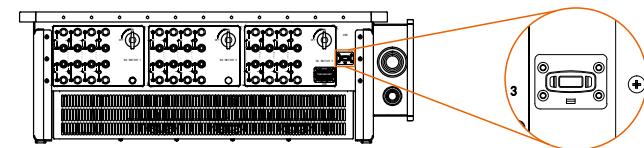

➤ Wi-Fi connection

Wi-Fi dongle connects to a local network within 50 m of the installation to enable access to the Monitoring Cloud platform.

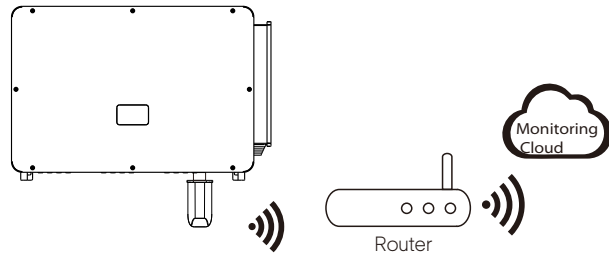

➤ LAN connection

If Wi-Fi isn't suitable, the LAN dongle enables users to connect to the network via an ethernet cable. Ethernet allows for a much more stable connection with less interference.

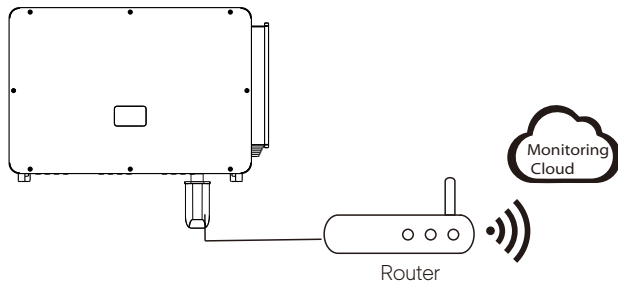

➤ 4G connection

4G dongle allows you to use a 4G connection to monitor your system without the option of connecting to a local network. (This product is not available in the UK)

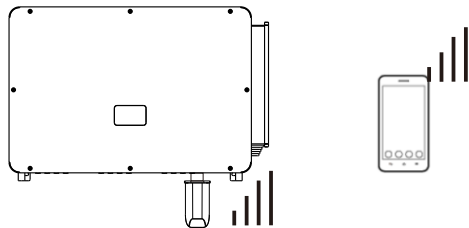

7. Start the Inverter

• Start inverter after checking all below steps:

- Check that device is fixed well on the wall or stand.
- Make sure all the DC breakers and AC breakers are disconnected.
- AC cable is connected to grid correctly.
- All PV panels are connected to inverter correctly, DC connectors which are not used should be sealed by cover.
- Turn on the DC switch to the "ON" position.

• Start the inverter

Inverter will start automatically when PV panels generate enough energy. Check the status of LED indicators and LCD screen, the LED indicators should be blue and the LCD screen should display the main interface.

For the inverter with LED indicators:

If the LED indicator is not on, please check the below:

- All the connections are right.
- All the external circuit breakers are closed.
- The DC switch of the inverter is in the "ON" position.

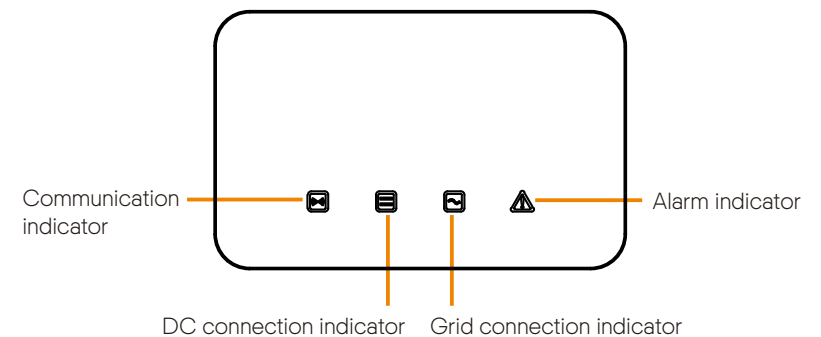

LED	Indicator status	Indicator status definition
Communication signal indicator (blue)	Always light on	The inverter communication is normal.
	Flashing	No communication data is sent or received for a long time.
DC side signal indicator (green)	Always light on	The inverter is in grid-connected state.
	Flashing	If the fault signal light is on, it indicates errors occur on the inverter DC side. If the fault signal light is off, it indicates no errors occur on the inverter DC side and at least one channel of MPPT input voltage is higher than 200 V.
	Always light off	The input voltage of all channels of MPPT is less than 200 V; Or DC switch is not turned on.
Grid connection indicator (green)	Always light on	The inverter is in grid-connected state.
	Flashing	If the fault signal indicator is on, it indicates errors occur on inverter AC side; If the fault signal indicator is off, AC grid is connected and the inverter is not in grid-connected state.
	Always light off	The inverter is not connected to the grid;
Inverter fault indicator (Red)	Always light on	The inverter is faulty
	Flashing	The inverter prompts warning
	Always light off	The inverter is currently in a normal state, and there is no fault.

Note:

- 1 When the inverter is in software upgrading state, all the indicators are blinking in turn;
- 2 When the inverter upgrade fails, other three indicators will be off except the inverter fault indicator (Red);
- 3 After the inverter upgrade succeeded, all the indicators will be off;
- 4 When the inverter is in the aging mode, the inverter fault indicator (Red) is flashing and other indicators keep the current state.

For the inverter with LCD screen:

Below is the three different states when operating, which means inverter starting up successfully.

Waiting: Inverter is waiting to checking when DC input voltage from panels is greater than 160 V (lowest start-up voltage) but less than 200 V (lowest operating voltage).

Checking: Inverter will check DC input environment automatically when DC input voltage from the PV panels exceeds 200 V and PV panels have enough energy to start inverter.

Normal: Inverter begins to operate normally, meanwhile the LCD displays the main interface. Enter the setting interface to set the parameters when it is the first time to start up.

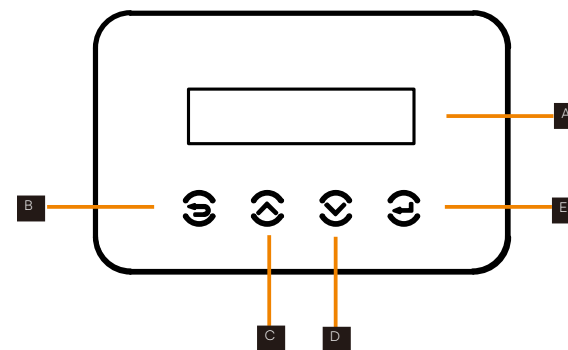

Object	Name	Description
A	LCD Screen	Display the information of the inverter.
B	ESC key	Return to the previous interface or cancel the setting
C	Up key	Move the cursor up or increase the setting value.
D	Down key	Move the cursor down or decrease the setting value.
E	Enter key	Enter the selected interface or confirm the setting.

8. Firmware Upgrading

- Upgrade preparation

1) Prepare a U disk (USB 2.0 / USB 3.0);



CAUTION!
Please make sure that the format is FAT or FAT 32.

2) Contact our service support to get the update files (“*.bin” and “*.txt” file), and store the two files in the root path of the U disk.

Files:
FORTH_Vxxx.xx.bin
UpdateConfig.txt



CAUTION!
The bin name listed in the “*.txt” file must be same as the “*.bin” name.

- Upgrade steps

USB disk can be plugged when the inverter is in normal status.

1) Plug the U disk into the upgrading port below: If the Wi-Fi dongle is connected to the port, please remove the dongle first.

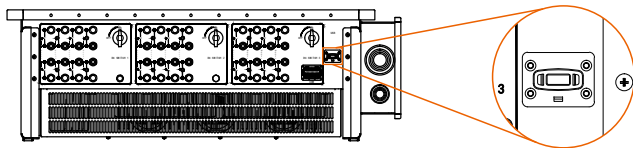

NOTE!
After U disk plug in, the four indicator lights will be blinking in turn.
(Communication indicator: blue; DC connection indicator: green;
Grid connection indicator: green; Alarm indicator: Red)

2) Wait approximately 15 seconds. The system will start upgrading when the four indicator lights turn off and the buzzer starts buzzing.

3) When the buzzer stops buzzing and the indicator lights starts blinking again, it means that ARM program is upgraded successfully. And then the system will start other program upgrading.

If upgrading succeeds, the communication indicator (blue) turns off and other indicators are on;

If upgrading fails, only alarm indicator (red) is on. Please contact our service support for solutions.



NOTE!
After upgrading finished, the current state of indicator will be kept for 1 min and the inverter will be switched on automatically.

9 Setting for Inverter with LCD

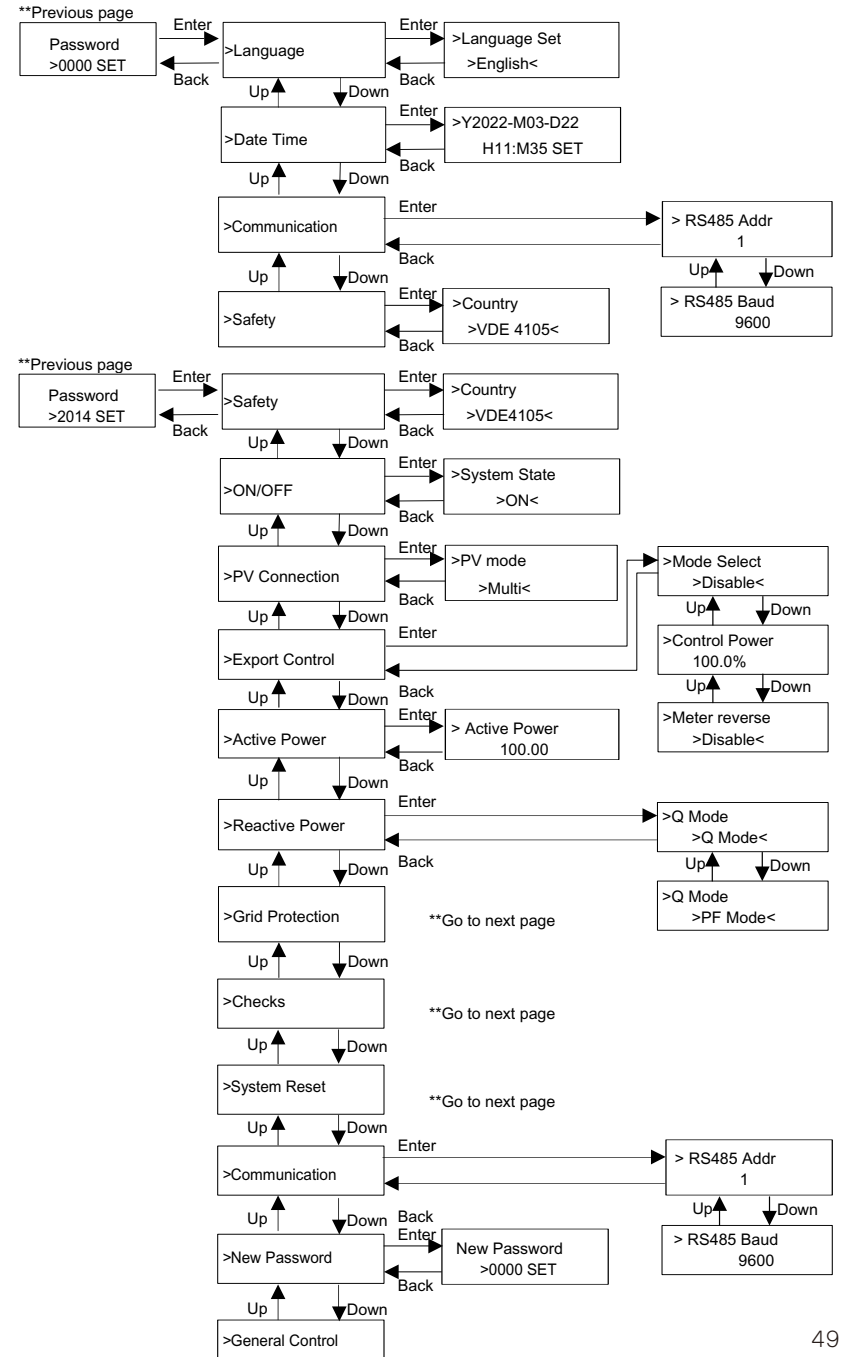
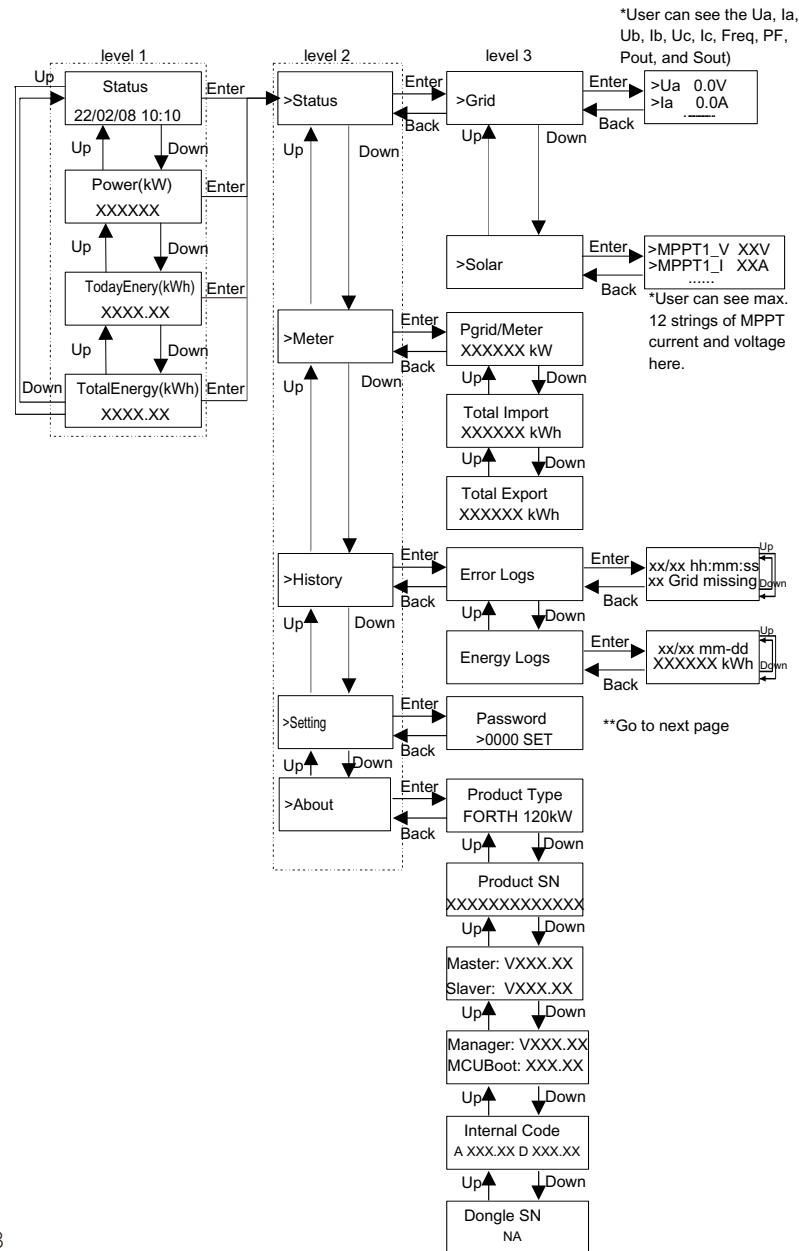

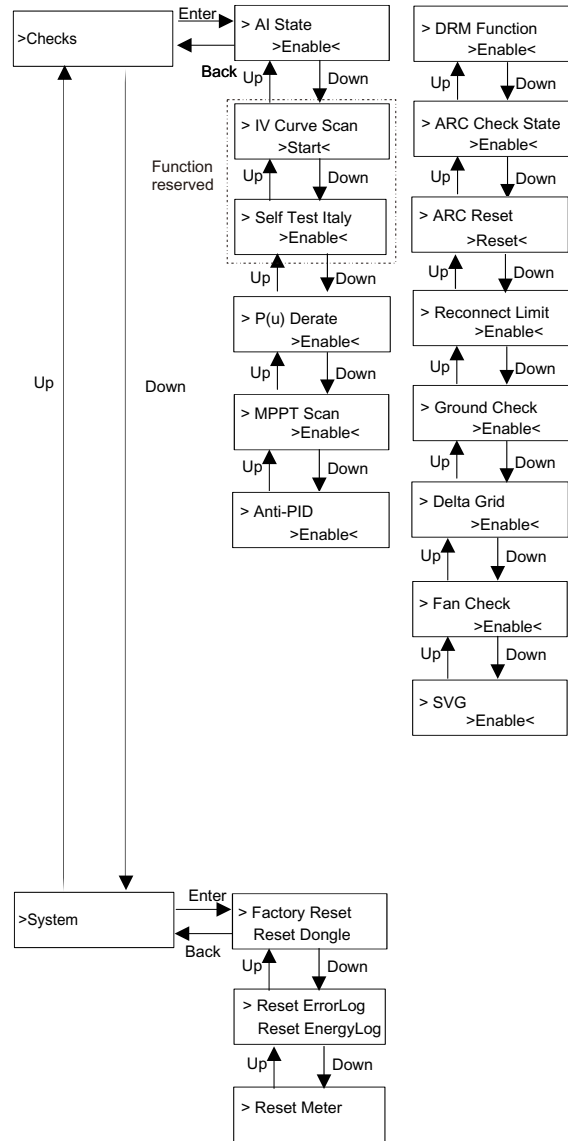

➤ LCD Digital Display

The main interface (Level 1) is the default interface, the inverter will automatically jump to this interface when the system started up successfully or not operated for a period of time.

“Status” shows the time and the current status “Waiting”, “Checking”, “Running”, “Fault” and “Upgrading”; “Power” means the timely output power; “TodayEnergy” means the power generated within the day; “TotalEnergy” means the power generated until now. Press “Up” and “Down” to review the information.

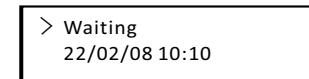

➤ Menu interface

The menu interface (Level 2) is a transfer interface for the user to get into other interface to change the setting or obtain the information.

-User can get into this interface by pressing “Enter” key when LCD displays the main interface.

-User can select “Up” and “Down” key, and press “Enter” to confirm the selection.

==== Menu =====

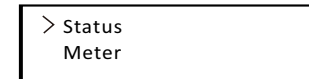

• Status

The status function contains “Grid” and “Solar”.

Press “Up” and “Down” to select and press “Enter” to confirm the selection, press “ESC” to return to menu.

==== Status =====



a) Grid

This status shows the current grid condition such as voltage, current, and output power, etc. Pout measures the output of the inverter; Pgrid means active power; Qout means reactive power; Sout means the apparent power. Press “Up” and “Down” button to review the parameter, press “ESC” to return to Status .

==== Gird =====

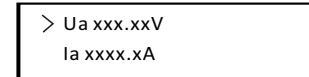

b) Solar

This interface shows the input current of PV. Totally 12 strings of MPPT current and voltage can be checked for the inverter in maximum.

```

===== Solar =====
> MPPT1_V xxxxV
MPPT1_I xxxxA
  
```

• Meter

The user can check the import and export energy by this function. There are three parameters: "Pgrid/Meter", "Total Import" and "Total Export". Press "Up" and "Down" to review the values. If no meter is connected, the parameters here will display 0.

```

===== Meter =====
Total Import:
0.0kWh
  
```

• History

History contains error logs and energy logs.

The Error log contains error information happened. It can record six items at most. Press "Up" and "Down" button to review parameter. Press "ESC" to return to the main interface.

```

===== Error Logs =====
02/08 10:10:10
Grid Lost
  
```

The Energy log contains the energy generated within the day. Press "Up" and "Down" button to select the date to check the log recorded on that day. Press "ESC" to return to the main interface.

```

===== Energy Logs =====
02/08
XXXX kWh
  
```

• Settings

Setting function is used for setting the inverter for safety, system on/off, PV connection mode, etc. To set the parameter, please input the password. For users, the default password is "0000", which allows the user to review and modify "Language", "Date Time", "Communication" and "Safety".

```

===== Setting =====
Password
>0000 SET
  
```

a) Language

Here user can set the language. At present, English is only available for choosing.

```

===== Language =====
> Language Set
> English <
  
```

b) Date Time

This interface is for the user to set the system date and time. Increase or decrease the word by pressing "Up" or "Down" key. Press "Enter" to confirm and alternate to next word. After all the words are confirmed, select "SET" and press "Enter" to confirm the password.

```

===== Language =====
> Y2022-M03-D22
H11:M35 SET
  
```

c) Communication

RS485 Addr: the modbus address of the external communication protocol.

RS485 Baud: The Baud rate of the external communication protocol. At present, 4800, 9600 and 19200 are supported.

With this function, the inverter can communicate with the computer, through which the operating status of the inverter can be monitored. When multiple inverters are monitored by one computer, RS485 communication addresses of different inverters need to be set.

```

= Communication Parameter =
> RS485 Addr
1

= Communication Parameter =
> RS485 Baud
9600
  
```

d) Safety

The user can only view the safety standard here.

```

===== Safety =====
> country
> VDE4105<
  
```

For installers, the default password is "2014", which allows the installer to review and modify necessary settings complying to the local rules and regulations. If further advanced setting is required, please contact us or the distributor for assistance. Press "Enter" to enter the password setting interface, press "up" and "Down" when it is flashing, then press "Enter" to confirm the set value. Finally, select "SET" and press "Enter" to confirm the password.

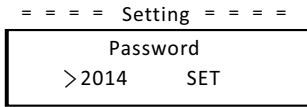

After inputting the password, the information of the LCD interface is shown as below.

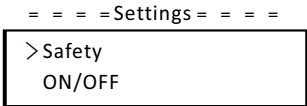

a) Safety

The installer can set the safety standard here according to different countries and grid tied standards. There are several standards for choice.

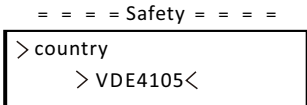

b) ON/OFF

"ON" means the inverter is in working state, and the inverter is in the default state.

"OFF" means that the inverter stops running and only the LCD screen is on.

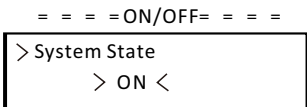

c) PV Connection

The user can select the PV connection type by this function.

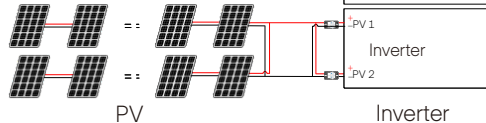
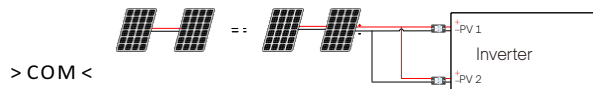
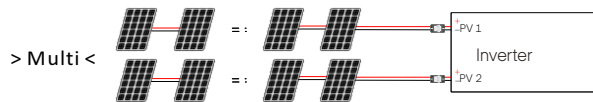
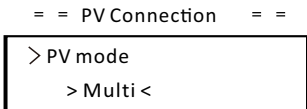

d) Export Control

With this power control function, the inverter can control the energy exported to the grid. The "Control Power" can be set by the installer. When you set 100% for control power, it means the energy can be exported to grid with full power. When you set 0%, Exporting to grid is limited. Please set the percentage according to the actual need.

Choose "Disable" means the function will not be activated.

Press "Up" and "Down" button to select and press "Enter" to confirm it.

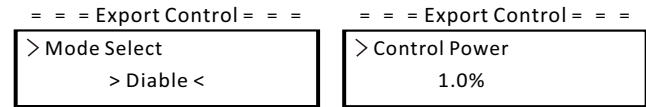

If the meter is connected reversely, please the enable "Meter reverse" function.

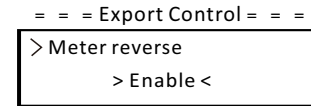

For Australia, there will be "Meter" and "CT" options additionally. Installer can set "Soft Limit" and "Hard Limit" for export control.

e) Active power

This interface is used to set the active power according to the requirement of utility grid.

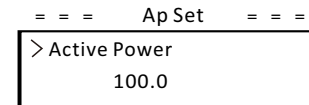

f) Reactive power

This interface is used to set the active power. Please set the value according to the requirement of utility grid.

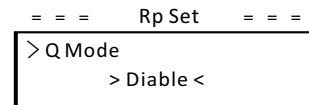

g) Grid Protection

Usually end user do not need to set the grid protection. All default value have been set before leaving factory according to safety rules.

If reset is needed, any changes should be made according to the requirements of local grid.

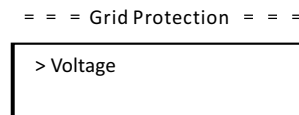

h) Checks

This interface is used to activate the needed functions, including “AI State”, “P(u) Derate”, “MPPT Scan”, etc.

```

===== Checks =====
> AI State
  > Enable<
  
```

l) System

Here you can reset dongle, errorlogs, energylogs, and meter. In addition, restoring factory default setting is allowed.

Take “Reset Meter” as an example:

The user can clear the meter energy by this function. Press “Up” or “Down” button to select and press “Enter” to confirm it. (The user can select “Start” to reset meter if the user purchases our meter)

```

===== System Parameter=====
Reset EnergyLog
> Reset Meter
  
```

j) Communication

Please refer to “Communication” under “Setting” after inputting password “0000”.

k) New Password

The user can set the new password here. We need to increase or decrease the word by pressing “Up” or “Down” button. Press “Enter” to confirm and alternate to next word. After word is confirmed, Press “SET” and “Enter” to reset the password.

```

=====New Password=====
Password
>0000 SET
  
```

l) For Australia, there will be an option of “General Control” additionally. Here you can set the “Soft Limit” and “Hard Limit” for general control.

• About

This interface shows information of the inverter, include model, SN, software version of master DSP, slaver and ARM board and internal code.

```

===== About =====
Product Type
FORTH 120KW
  
```

10 Troubleshooting

10.1 Troubleshooting

This section contains information and procedures for solving possible problems with the inverters, and provides you with troubleshooting tips to identify and solve most problems that could occur with the the inverters.

This section will help you narrow down the source of any problems you may encounter. Please read the following troubleshooting steps.

Check warnings or fault messages on System Control Panel or Fault codes on the inverter information panel. If a message is displayed, record it before doing anything further.

Attempt the solution indicated in troubleshooting lists.

If your inverter’s information panel is not displaying a Fault light, check the following list to make sure that the present state of the installation allows proper operation of the unit.

- Is the inverter located in a clean, dry, adequately ventilated place?
- Have the DC input breakers been opened?
- Are the cables adequately sized and short enough?
- Are the input and output connections and wiring in good condition?
- Are the configurations settings correct for your particular installation?
- Are the display panel and the communications cable properly connected and undamaged?

Contact our Customer Service for further assistance. Please be prepared to describe details of your system installation and provide model and serial number of the unit.

error	Diagnostics and Solutions
ISO_Fail	PV insulation impedance below safety value 1. Check PV electrical connection; 2. Check the grounding of inverter; 3. Contact the installer;
Meter_Oppsite	Incorrect meter direction 1. Confirm whether the current direction of the meter is correct; 2. Contact the installer
Remote_Off	The inverter receives the shutdown command and is in the shutdown state 1. Send the startup command through app or web to re run the inverter; 2. Contact the installer
Freq_Cfg_Err	Grid rated frequency setting error 1. Check whether the state / power grid directive is set correctly; 2. Contact the installer
Gnd_Conn_Err	Inverter grounding fault 1. Check whether the Neutral line of the power grid is correctly connected; 2. Check whether the inverter ground wire is correctly connected; 3. Try to re run the inverter; 4. Contact the installer;
PV01_Reverse	Reversed PV connection on MPPT1 (PV01-PV12 respectively represent the PV input channel 1-12) 1. Check whether the electrical connection of PV module is correct; 2. Contact the installer
PV_VolHigh	PV input voltage is higher than the allowable value (PV1-PV12 respectively represents 1-12 PV overvoltage) 1. Check the PV voltage and confirm that it is within the allowable range; 2. Reduce the number of PV modules in series and reduce PV voltage; 3. Contact the installer
BST_SW_OCP	MPPT software overcurrent 1. Check whether the PV input is short circuited; 2. Try to restart the inverter; 3. Contact the installer
BST_HW_OCP	MPPT hardware overcurrent 1. Check whether the PV input is short circuited; 2. Try to restart the inverter; 3. Contact the installer
Grid_Loss	Power failure of power grid / disconnection of AC line or AC switch. 1. Check whether the grid voltage is normal; 2. Check the power grid electrical connection AC switch; 3. Try to restart the inverter
GridVol_OP1	The grid voltage exceeds the allowable value 1. Check whether the grid voltage is within the allowable range; 2. Try to re run the inverter;
GridVol_UP1	The grid voltage is lower than the allowable value 1. Check whether the grid voltage is within the allowable range; 2. Try to re run the inverter;
GridVol_OP_10M	The average grid voltage in 10 minutes exceeds the allowable value 1. Check whether the grid voltage is within the allowable range; 2. Try to re run the inverter;

error	Diagnostics and Solutions
GridVol_OP_INST	Instantaneous high voltage of power grid 1. Check whether the grid voltage is within the allowable range; 2. Try to re run the inverter;
GridFreq_OP1	Grid frequency exceeds allowable value 1. Check whether the power grid frequency is within the allowable range; 2. Try to re run the inverter;
GridFreq_UP1	The grid frequency is lower than the allowable value 1. Check whether the power grid frequency is within the allowable range; 2. Try to re run the inverter;
GridPhase_Loss	Loss of grid phase voltage 1. Check the grid voltage; 2. Check the power grid electrical connection AC switch; 3. Try to re run the inverter
Grid_Unbalance	Grid voltage imbalance 1. Check whether the grid voltage is within the allowable range; 2. Try to re run the inverter;
Grid_FRT	Grid fault 1. Check whether the grid voltage is within the allowable range; 2. Try to re run the inverter;
DCBus_HW_OVP	Bus hardware overvoltage 1. Check the PV voltage and confirm that it is within the allowable range; 2. Try to restart the inverter; 3. Contact the installer
PBus_FSW_OVP	Bus software overvoltage 1. Try to restart the inverter; 2. Contact the installer
NBus_FSW_OVP	Bus software overvoltage 1. Try to restart the inverter; 2. Contact the installer
DCBus_SW_OVP	Bus software overvoltage 1. Check the PV voltage and confirm that it is within the allowable range; 2. Try to restart the inverter; 3. Contact the installer
DCBus_SW_UVP	Bus software undervoltage 1. Check the PV voltage and confirm that it is within the allowable range; 2. Try to restart the inverter; 3. Contact the installer
DCBus_Unbalance	Bus imbalance 1. Try to restart the inverter; 2. Contact the installer
PV_Above_Bus	The PV voltage is higher than the Bus voltage 1. Try to restart the inverter; 2. Contact the installer

error	Diagnostics and Solutions
DcBus_SSErr	Bus soft start failure 1. Try to restart the inverter; 2. Contact the installer
SunPWR_Weak	Low PV power 1. Try to restart the inverter; 2. Contact the installer
InvRelay_Err	Relay fault 1. Try to restart the inverter; 2. Contact the installer
Relay_OnErr	Relay pull in fault 1. Try to restart the inverter; 2. Contact the installer
Inv_SW_OCP	Inverter software overcurrent 1. Try to restart the inverter; 2. Contact the installer
Inv_PkCur_OL	Inverter peak overcurrent fault 1. Try to restart the inverter; 2. Contact the installer
Inv_HW_OCP	Inverter hardware overcurrent 1. Try to restart the inverter; 2. Contact the installer
Inv_DCI_Err	DCI exceeds allowable value 1. Try to restart the inverter; 2. Contact the installer
Inv_SC_Err	Inverter peak overcurrent fault 1. Try to restart the inverter; 2. Contact the installer
GFCI_CT_Err	GFCI sensor failure 1. Try to restart the inverter; 2. Contact the installer
GFCI_Err	GFCI failure 1. Check whether the inverter ground wire is correctly connected; 2. Try to restart the inverter; 3. Contact the installer
Inv_HW_OCPA	Inverter hardware overcurrent fault 1. Try to restart the inverter; 2. Contact the installer
Bst_IGBT_NTC_OTP	Boost module temperature above allowable value 1. Confirm that the inverter is well ventilated; 2. Try to restart the inverter; 3. Contact the installer

error	Diagnostics and Solutions
Inv_IGBT_NTC_OTP	The temperature of inverter module is higher than the allowable value 1. Confirm that the inverter is well ventilated; 2. Try to restart the inverter; 3. Contact the installer
AC_TB_NTC_OTP	The AC terminal temperature is higher than the allowable value 1. Confirm that the inverter is well ventilated; 2. Try to restart the inverter; 3. Contact the installer
Envir_Tmp_High	The internal temperature is higher than the allowable value 1. Confirm that the AC terminal of the inverter is well wired; 2. Try to restart the inverter; 3. Contact the installer
Envir_Tmp_Low	The internal temperature is lower than the allowable value 1. Confirm that the inverter is well ventilated; 2. Try to restart the inverter; 3. Contact the installer
TmpSensor_Loss	Temperature sensor connection failure 1. Try to restart the inverter; 2. Contact the installer
Comm_SPI_Err	Internal SPI failure 1. Try to restart the inverter; 2. Contact the installer
Comm_CAN_Err	Internal CAN failure 1. Try to restart the inverter; 2. Contact the installer
EPRM_RW_Err	EEPROM fault 1. Try to restart the inverter; 2. Contact the installer
FAN1_Err	Fan 1 fault 1. Try to restart the inverter; 2. Contact the installer
FAN2_Err	Fan 2 fault 1. Try to restart the inverter; 2. Contact the installer
MOV_AC_Err	AC lightning protection module failure 1. Try to restart the inverter; 2. Contact the installer
MOV_DC_Err	DC lightning protection module failure 1. Try to restart the inverter; 2. Contact the installer
Type_Model_Err	Model setting error 1. Try to restart the inverter; 2. Contact the installer
SW_VerMisMatch	Software version unmatched error 1. Try to restart the inverter; 2. Contact the installer

10.2 Routine Maintenance

Inverters do not need any maintenance or correction in most condition, To ensure that the inverter can operate properly for a long term, you are advised to perform routine maintenance on it. Before cleaning the system, connecting cables, and maintaining the grounding reliability, power off the system.

- Fan Maintenance

The external fan of inverter is in operation for a long time. In order to keep the fan in normal working state, it is necessary to clean the fan regularly (it is recommended to clean it once a year). If the service life is too long, the fan may fail, and the fan needs to be repaired or replaced. The maintenance or replacement requires professional operation.

Step 1. Before maintenance of fan, the AC connection must be disconnected, then the DC switch must be disconnected and wait 5 minutes till the inverter is completely OFF.

Step 2. Remove the fan support fixing screw as shown in the figure below.

Step 3. Pull out the fan bracket, stop at the position about 150 mm, then pull off the fan waterproof connector, then pull the fan bracket again to pull out the whole bracket.

Step 4. Clean, repair, or replace the fan.

Step 5. Restore the installation of fan bracket and tighten the fixing screws.

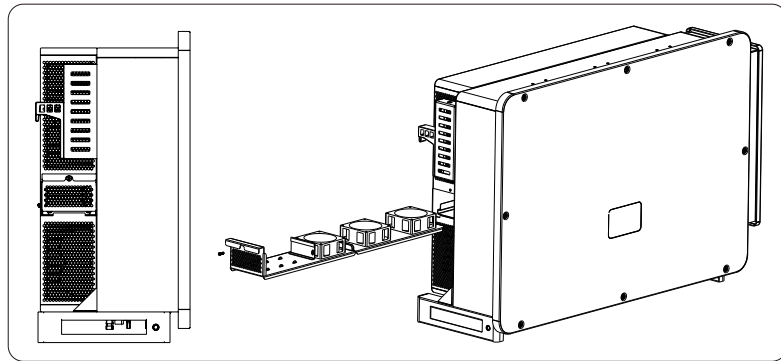

- Safety checks

Safety checks should be performed at least every 12 months by manufacturer's qualified person who has adequate training, knowledge, and practical experience to perform these tests. The data should be recorded in an equipment log. If the device is not functioning properly or fails any of test, the device has to be repaired. For safety check details, refer to this manual, section 2 Safety instruction and EC Directives.

- Maintain periodically

Only qualified person may perform the following works.

During the process of using the inverter, the manage person shall examine and maintain the machine regularly. The concrete operations are follow.

1) Check that if the cooling fins on the rear of inverter are covered by dirt, and the machine should be cleaned and absorbed dust when necessary.

This work shall be check from time to time.

2) Check that if the indicators of the inverter are in normal state, check if the display of the inverter (if it has screen) is normal. This check should be performed at least every 6 months.

3) Check that if the input and output wires are damaged or aged. This check should be performed at least every 6 months.

4) Check whether the ground terminal and ground cable are securely connected and all terminals and ports are properly sealed. This check should be performed at least every 6 months.

5) You should get the inverter panels cleaned and their safety checked at least every 6 months.

11 Decommissioning

11.1 Dismantling the Inverter

- Switch off the DC and AC switch/breaker and disconnect the inverter from DC Input and AC output.
- Wait for 5 minutes for de-energizing.
- Disconnect communication and optional connection wirings.
- Remove the inverter from the bracket.
Remove the bracket if necessary.



WARNING!

Before dismantling the inverter, please be sure to disconnect the DC switch, and then unplug the PV and AC cables, otherwise it will lead to an electric shock hazard.

11.2 Packaging

If possible, please pack the inverter with the original packaging. If it is no longer available, you can also use an equivalent carton that meets the following requirements.

- Suitable for loads more than 80 kg.
- With handle.
- Can be fully closed.

11.3 Storage and Transportation

Store the inverter in dry place where ambient temperatures are always between -25°C - $+60^{\circ}\text{C}$. Take care of the inverter during the storage and transportation, keep less than 4 cartons in one stack.

When the inverter or other related components need to be disposed. Have it carried out according to local waste handling regulations. Please be sure to deliver wasted inverters and packing materials to certain site, which can assist relevant department to dispose and recycle.

11.4 Disposing of the inverter

If the inverter service life expires, dispose of it according to the local disposal rules for electrical equipment waste.

12 Disclaimer

The inverters shall be transported, used and operated under restricted conditions. We will not provide any service, technical support or compensation in case of the following circumstances, including but not limited to:

- The inverter is damaged by force majeure (such as earthquake, flooding, thunderstorm, lighting, fire hazard, volcanic eruption, etc.);
 - The inverter's warranty is expired, but not extended;
 - The inverter's SN, warranty card or invoice cannot be provided;
 - The inverter is damaged by man-made cause;
 - The inverter is used or operated against any items in local policy;
 - The installation, configuration and commissioning of the inverter doesn't meet the requirements mentioned in this manual;
 - The inverter is installed, refitted or operated in improper ways;
 - The inverter is installed, operated under improper environment or electrical condition;
 - The inverter is changed, updated or disassembled on hardware or software without authority from us;
 - The communication protocol from other illegal channels is used; and
 - The monitoring or control system is used without authority from us.
- SolaX reserves the right for the final explanation.

Warranty Registration Form



For Customer (Compulsory)

Name Country

Phone Number Email

Address

State Zip Code

Product Serial Number

Date of Commissioning

Installation Company Name

Installer Name Electrician License No.

For Installer

Module (If Any)

Module Brand

Module Size(W)

Number of String Number of Panel Per String

Battery (If Any)

Battery Type

Brand

Number of Battery Attached

Date of Delivery Signature

Please visit our warranty website: <https://www.solaxcloud.com/#/warranty> to complete the online warranty registration or use your mobile phone to scan the QR code to register.

For more detailed warranty terms, please visit SolaX official website: www.solaxpower.com to check it.





PLEASE REGISTER THE WARRANTY IMMEDIATELY AFTER INSTALLATION!
GET YOUR WARRANTY CERTIFICATE FROM SOLAX!
KEEP YOUR INVERTER ONLINE & WIN SOLAX POINTS!

1

Open your camera app and point your device at the QR code



2

Wait for the camera to recognize the QR code



3

Click banner or notification when it appears on the screen



4

Warranty registration page will be loaded automatically

