



100% PURE SINE WAVE HOME INVERTER

USER'S MANUAL

SOLAR INVERTER

300W/400W/500W/600W/800W/1000W

Please download the software "PowerMonitor 1.6.84".

Download link: <https://en.must-ee.com>



Appliances



PC



TV



Light



Electric fan

Table Of Contents

GENERAL PRECAUTIONS	1
PERSONNEL PRECAUTIONS	1
INTRODUCTION	2
PRODUCT OVERVIEW	2
INSTALLATION	3
Mounting the Unit	3
Battery connection	4
OPERATION	6
LED indicators & audible alarms	6
LCD display	6
Display Select	8
LCD Setting	10
Operating mode description	12
Fault reference code	13
COMMUNICATION	14
TROUBLE SHOOTING	14
SPECIFICATIONS	15

ABOUT THIS MANUAL

Purpose

This manual describes the assembly, installation, operation and troubleshooting of this unit. Please read this manual carefully before installations and operations. Keep this manual for future reference.

Scope

This manual provides safety and installation guidelines as well as information on tools and wiring.

The following cases are not within the scope of warranty:

- (1) Out of warranty.
- (2) Series number was changed or lost.
- (3) Battery capacity was declined or external damaged.
- (4) Inverter was damaged caused of transport shift, remissness, ect external factor.
- (5) Inverter was damaged caused of irresistible natural disasters.
- (6) Not in accordance with the electrical power supply conditions or operate environment caused damage.

GENERAL PRECAUTIONS

1. Before using it, read all instructions and markings:

(1) inverter (2) the batteries (3) this manual

2. CAUTION --To reduce risk of injury, charge only lead-acid rechargeable batteries. If customer use flooded batteries, they must maintain them. Other types of batteries may cause damage and injury.
3. Do not expose it to rain, snow or liquids of any type. It is designed for indoor.
4. Do not disassemble it. Take it to a qualified service center when service or repair is required.
5. To prevent the risk of electric shock, disconnect all wiring before attempting any maintenance or cleaning. Turning off the unit will not reduce this risk.
6. WARNING: Provide ventilation to outdoors from the battery compartment. The battery enclosure should be designed to prevent accumulation and concentration of hydrogen gas at the top of the compartment.
7. NEVER charge a frozen battery and connect the inverter with 12V to 24V battery.
8. Input/output AC wiring must be no less than 16 AWG gauge copper wire and rated for 75 °C or higher. Battery cable must be rated for 75°C or higher and should be no less than 6AWG gauge.
9. Be extra cautious when working with metal tools around batteries. Short-circuiting the batteries could cause an explosion.
10. Read the battery manufacturer's installation and maintenance instructions prior to operating.

PERSONNEL PRECAUTIONS

1. Have plenty of fresh water and soap nearby in case battery acid contacts skin, clothing or eyes.
2. Avoid touching eyes while working near batteries.
3. NEVER smoke or allow a spark or flame in vicinity of a battery.
4. Remove personal metal items such as rings, bracelets, necklaces, and watches when working with batteries. Batteries can provide heavy short-circuit current, enough to make metal melt and causes severe burn.
5. If a remote or automatic generator start system is used, disable the automatic starting circuit or disconnect the generator to prevent accident during servicing.

FOLLOW STANDARD.

EN 60950-1:2006+A2:2013+A11:2009+A1:2010+A12:2011
EN 55022:2010. EN 55024:2010. EN 61000-3-3:2008

INTRODUCTION

It is a cost effective, intelligent solar inverter. The comprehensive LCD offers user-configurable and easy-accessible button adjustment such as battery charge current, battery charge Voltage, frequency, buzzer etc.

Features:

- Sine wave inverter
- Adjustable charging current from utility
- Adjustable battery charging current
- 3 steps charging algorithm
- Friendly user interface
- Multi-function display
- Overload and short-circuit protection
- Battery reverse polarity protection
- Deep discharge protection
- Automatic voltage regulation
- Communication with PC

PRODUCT OVERVIEW

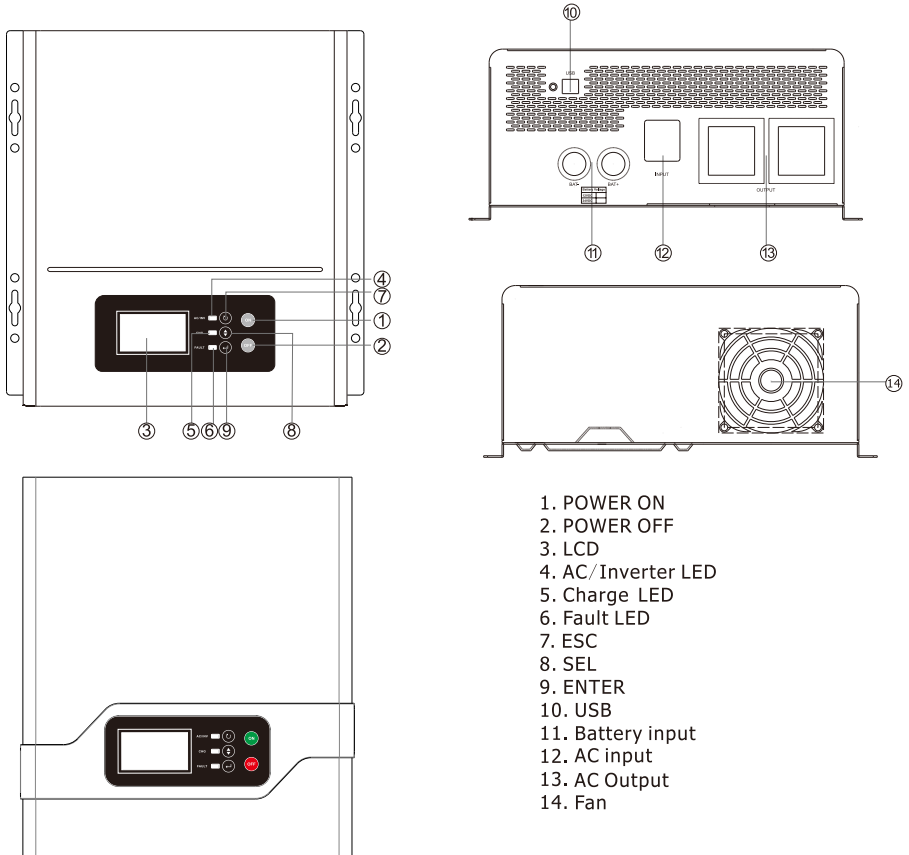

INSTALLATION

Unpacking and inspection

Before installation, please inspect the unit. Be sure that nothing inside the package is damaged. You should have received the following items inside of package.

- The unit X 1
- Communication cable X 1
- User manual X 1
- AC input cable X 1

Mounting the Unit

Consider the following points before selecting where to install:

- Do not mount the inverter on flammable construction materials.
- Mount on a solid surface
- Install this inverter at eye level in order to allow the LCD display to be read at all times.
- For proper air circulation to dissipate heat, allow a clearance of approx. 200mm to the side and approx. 300mm above and below the unit.
- The ambient temperature should be between 0°C and 40°C to ensure optimal operation.
- The recommended installation position is to be adhered to the wall vertically.
- Be sure to keep other objects and surfaces as shown in the below diagram to guarantee sufficient heat dissipation and to have enough space for removing wires.

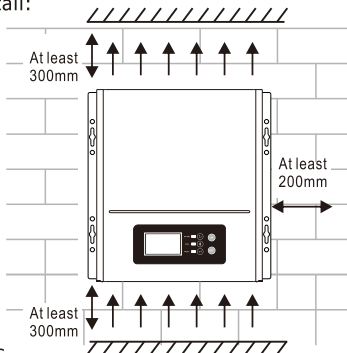

SUITABLE FOR MOUNTING ON CONCRETE OR OTHER NON-COMBUSTIBLE SURFACE ONLY.

Install the unit by screwing four screws.

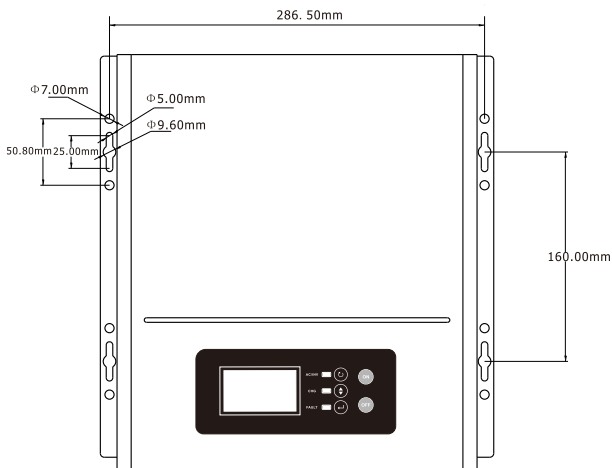

Battery connection

Step1: Away the cover of external battery terminal.

Step2: Following battery polarity guide printed near the battery terminal.

RED cable to the positive terminal(+);

BLACK cable to the negative terminal (-);

WARNING! Please use the appropriate battery cable. Please refer to the following table.

Model	Battery voltage	Wire size
300W	12V	1*10AWG
400W	12V	1*10AWG
500W	12V	1*8AWG
600W	12V	1*8AWG
	24V	1*10AWG
800W	12V	2*10AWG
	24V	1*10AWG
1000W	12V	2*8AWG
	24V	1*8AWG

Step3: Install a DC breaker in a positive line.

The rating of the DC breaker must be according to the inverter's battery current (75 A for 24V battery, 150 A for 12V battery).

Note: you must keep the DC breaker off.

Step4: Connect battery cable to the external batteries.

Note: For the user operation safety. We strongly recommend that you should use tape to isolate the battery terminals before you start to operate the unit.

1) Single battery connection

When using a single battery, its voltage must be equal to the Nominal DC voltage of the unit.

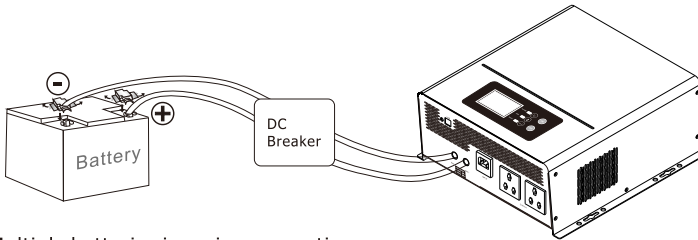

2) Multiple batteries in series connection

All batteries must be equal in voltage and amp hour capacity. The sum of their voltages must be equal to the nominal DC voltage of the unit.

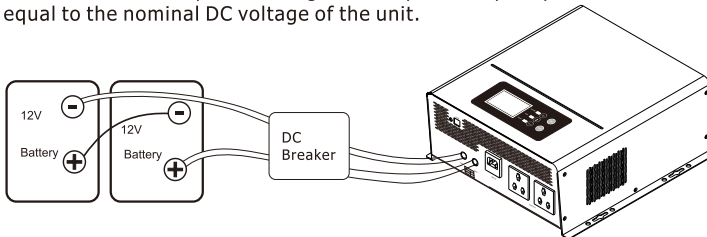

2) Multiple batteries in parallel connection

Each battery's voltage must be equal to the nominal DC voltage of the unit.

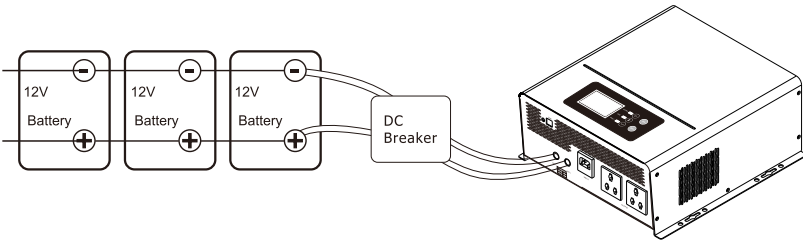

Step 5: Make sure to connect the polarity of battery side and unit correctly.

- Connect positive pole (Red) of battery to the positive terminal (+) of the unit.
- Connect Negative pole (Black) of battery to the negative terminal (-) of the unit.

Step 6: Put the covers back to the external battery terminals.

Step 7: Take the DC breaker on.

WARNING! Wiring must be performed by a qualified person.

Connect to utility and charge battery

WARNING! Please do not misconnect input and output connector.

Plug the AC input cord into the wall outlet. Battery of the machine will be charged automatically

OPERATION

Press "ON" for 2 seconds to turn on the unit. The unit will work automatically in line mode or inverter mode according to input utility status. When "OFF" is pressed and hold for 2 seconds, the unit will be turned off. When machine is working, buzzer can be controlled by pressing "ON".

The display panel, shown in below chart, is on the front panel of the inverter. It includes four front indicators, three function keys and a LCD display, indicating the operating status and input/output power information.

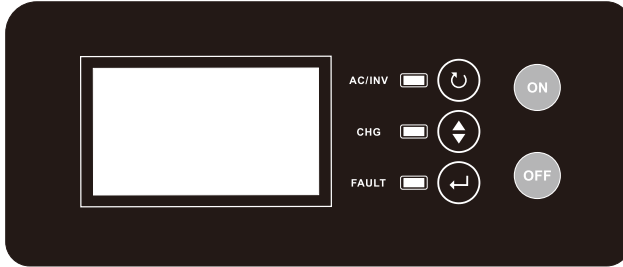









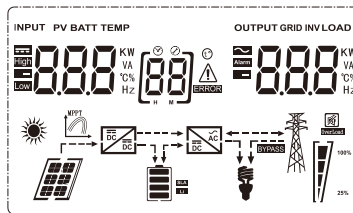



LED indicators & audible alarms











There are three LED indicators in the front panel.

LED_FAULT	Warning	Buzzing every 2 seconds and blinking red LED
	Fault	Buzzing continuously and red LED is on
	Normal	Red led is off
LED_CHG	Charging	Yellow led is on
	Stop charge	Yellow led is off
LED_AC/INV	Backup mode	Blinking Green led
	Line mode	Green led is on
	Charger mode	Green led is off

LCD Display



Icon		Function description
Input Source Information and Output Information		
AC	Indicates the AC input	
INPUT PV BATT TEMP 	Indicate input voltage, input frequency, PV voltage, battery voltage and charger current. Indicate output voltage, output frequency, load in VA, load in Watt and discharging current.	
Configuration Program and Fault Information		
	Indicates the setting programs.	
	Indicates the warning and fault codes. Warning: flashing  with warning code. Fault: lighting  with fault code.	
Output Information		
OUTPUT GRID INV LOAD 	Indicates output voltage, output frequency, load percent, load in VA, load in W.	
Battery Information		
	Indicates battery level by 0-25%, 25-50%, 50-75% and 75-100% in battery mode and charging status in line mode.	
In AC mode, it will present battery charging status.		
Status	Battery voltage	LCD Display
Constant Current mode / Constant Voltage mode	<2V/cell	4 bars will flash in turns.
	2 ~ 2.083V/cell	Bottom bar will be on and the other three bars will flash in turns.
	2.083 ~ 2.167V/cell	Bottom two bars will be on and the other two bars will flash in turns.
	> 2.167 V/cell	Bottom three bars will be on and the top bar will flash.
Floating mode. Batteries are fully charged.		4 bars will be on.
In battery mode, it will present battery capacity.		
Battery voltage		LCD Display
0%~25%		
25%~50%		
50%~75%		
75%~100%		

Load Information				
	Indicates overload.			
	Indicates the load level by 0-24%, 25-50%, 50-74% and 75-100%.			
	0%~25%	25%~50%	50%~75%	75%~100%
				
Mode Operation Information				
	Indicates unit connects to the mains.			
	Indicates load is supplied by utility power.			
	Indicates the solar charger is working.			
	Indicates the DC/AC inverter circuit is working.			
Mute Operation				
	Indicates unit alarm is disabled.			

Display Select

The LCD display information will be switched in turns by pressing "SEL" key. The selectable table information is as following table.

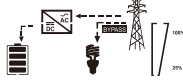
Selectable Information	LCD display
Input	<p>Input voltage=213 V, input frequency=50Hz</p> <p>INPUT</p> <p>213 ^v 500 ^{Hz}</p> 
Battery	<p>Battery voltage=13.2 V, battery current = 20A</p> <p>BATT</p> <p>13.2 ^v 20 ^A</p> 

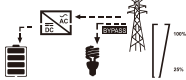
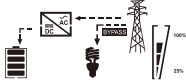
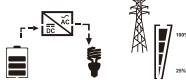
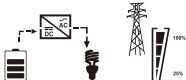
<p>Output</p>	<p>Output voltage=214 V, output frequency=50Hz</p> <p style="text-align: center;">OUTPUT</p> <p style="font-size: 2em; text-align: center;">214^V 500^{Hz}</p> 
<p>Load</p>	<p>Power = 630W, percent = 70%</p> <p style="text-align: center;">LOAD</p> <p style="font-size: 2em; text-align: center;">630^W 70[%]</p> 
<p>Load</p>	<p>Power = 1.07KW, apparent power=1.32KVA</p> <p style="text-align: center;">LOAD</p> <p style="font-size: 2em; text-align: center;">1.32^{KVA} 1.07^{KW}</p> 
<p>Temperature</p>	<p>inverter temperature = 40°C</p> <p style="text-align: center;">INV</p> <p style="font-size: 2em; text-align: center;">40^{°C}</p> 

LCD Setting

After pressing and holding "ENTER" button for 2 seconds, the unit will enter setting mode. Press "ENTER" button to select setting programs. Press "SEL" button to change parameter. Press "ESC" button for 2 seconds to exit. Most of the parameters will take effect when you exit from setting menu. But frequency and output voltage settings are special. The two settings will take effect, after resetting machine.

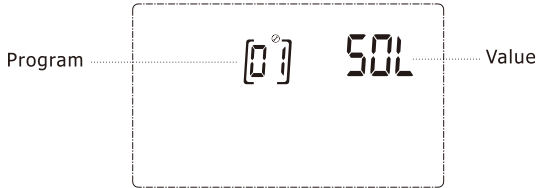

Setting program information

03	Output voltage	220V [03] 220 ^v		
		230V(default) [03] 230 ^v		
04	Output frequency	50Hz (default) [04] 500 ^{Hz}		
		60Hz [04] 600 ^{Hz}		
07	Auto restart when overload occurs	Restart disable [07] Lfd	Restart enable (default) [07] LfE	
		Model: 12 VDC	Model: 24 VDC	
13	Maximum utility charging current	5~25A (default value is 10A) [13] 10 ^A	5~15A (default value is 10A) [13] 10 ^A	
		13.8~14.5V (default value is 14.1V) [17] 14.1 ^v	27.6~29.0V (default value is 28.2V) [17] 28.2 ^v	
17	Absorption charge voltage			
18	Float charge voltage	13.5~14.5 V (default value is 13.6V) [18] 13.6 ^v	27.0~29.0 V (default value is 27.2V) [18] 27.2 ^v	

19	Shutdown voltage	10.0~12.0V (default value is 10.5V) [19] 10.5 ^v	20.0~24.0V (default value is 21.0V) [19] 21.0 ^v
23	Backlight	OFF (default) [23] LOF	
		ON [23] LON	
24	Buzzer	ON (default) [24] bON	
		OFF [24] bOF	







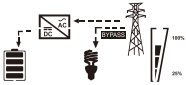
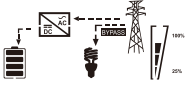
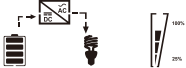







If you want to reset all the parameters, in operation menu, pressing "SEL" button for 2 seconds will enter into reset settings dialog. Please select "DEF" through "SEL" button. Press "ESC" button for 2 seconds to exit and all parameters will be default state.

00	Restore factory settings	no (default) [00] SET	yes [00] DEF
----	--------------------------	--------------------------	-----------------

Operating mode description

Selectable Information	Description	LCD display
Fault mode	If any fault has happened, the machine will enter to the mode. And fault code is displayed on the LCD.	
Charger mode	In this mode, the battery will be charged through grid power. When there are no grid, the machine will power off.	Charging by utility 
Line mode	Input power will provide energy to load directly. And it will charge the battery at the same time. If voltage of input power is outside of section, [200v, 240v], AVR will work. When input power is abnormal or satisfied with settings, the machine will switch to battery mode.	Charging by utility 
Battery mode	The unit will get energy from battery and provide to load.	Power from battery only 

Fault Reference Code

Fault Code	Fault Event	Icon on
02	Over temperature	[02] 
03	Battery voltage is too high.	[03] 
04	Battery voltage is too low.	[04] 
05	Output short circuited	[05] 
06	Inverter output voltage is high.	[06] 
07	Over load	[07] 
11	Main relay fault	[11] 
41	Input voltage is too low.	[41] 
42	Input voltage is too high.	[42] 
43	Input frequency is too low.	[43] 
44	Input frequency is too high.	[44] 
45	AVR fault	[45] 
51	Over current	[51] 
58	Inverter output voltage is low.	[58] 
77	Parameter error.	[77] 

COMMUNICATION

Refer to User Guide of SolarPowerMonitor.

TROUBLE SHOOTING

If machine enters into fault mode, please remove input power. And according to the table, deal with the followin problems.

LED/Buzzer	LCD	Explanation / Possible cause	What to do
Buzzer beeps And red LED is off	Blink battery ICON	Battery voltage is too Low.	Charge the unit at least 8 hours
	Blink load ICON	Over load	Decrease your load
Buzzer beeps continuously and red LED is on	Fault code 02	Temperature of machine is too high.	Power off and waiting for minutes
	Fault code 03	Battery voltage is too high.	Check the battery specifications
	Fault code 04	Battery voltage is too low.	Check the battery specifications
	Fault code 05	Output short circuited	Return to repair center
	Fault code 06	Inverter output voltage is high	Return to repair center
	Fault code 07	Over load	Decrease your load
	Fault code 11	Main relay fault	Restart the machine. If it still can't work, please return to repair center.
	Fault code 41	Input voltage is too low.	Check input power
	Fault code 42	Input voltage is too high.	
	Fault code 43	Input frequency is too low.	
	Fault code 44	Input frequency is too high.	
	Fault code 45	AVR fault	Restart the machine. If it still can't work, please return to repair center.
	Fault code 51	Output short circuited	Check if wiring is connected well and remove abnormal load.
	Fault code 58	Output voltage is too low.	Decrease your load
Fault code 77	Parameter error	Make sure that absorption charge voltage is higher than float charge voltage, and voltage in program 21 is higher than voltage in program 20.	

SPECIFICATIONS

CAPACITY	300W/400W/500W/600W/800W/1000W								
INPUT									
Voltage Range	140~280VAC +/-5%								
Frequency Range	50Hz+/-5Hz or 60Hz+/-5Hz								
OUTPUT									
Voltage Regulation	Battery mode					Line mode			
	220 or 230 VAC+/-5%					200 VAC ~ 240 VAC			
Output Frequency	60Hz or 50Hz								
Transfer Time	8 ms (typical), 12 ms (max)								
Waveform	sine wave								
BATTERY									
Battery Voltage	12Vdc					24Vdc			
Min battery voltage for power on	Shutdown voltage + 0.5V					Shutdown voltage + 1V			
Maximum Charge Current	300W	400W	500W	600W	800W	1000W	600W	800W	1000W
	10A	10A	15A	20A	25A	30A	10A	15A	15A
Over load	>110%~125%Load Fault after 60S >125% ~150%Load Fault after 3s >150% Load Fault after 500ms								
PHYSICAL									
Dimension (D*W*H) mm	391*325*187mm								
Net Weight (kg) (horizontal)	300W	400W	500W	600W	800W	1000W			
	6.0	8.2	9.5	10.6	12.6	13.2			
OTHER									
Storage temperature	-15°C to 55°C								
Ambient temperature	0°C~40°C								
Noise	≦ 60dB								
Communication	No								

**MUST**[®]

GUARANTEE CERTIFICATE

Serial No.: _____

Customer's Name				Contact Person	
Address				Telephone No.	
Product/Model:		Post Code		Fax No.	
Date of purchase			Expire Date		
Dealer Signature			Customer Signature		

**MUST**[®]

GUARANTEE CERTIFICATE

Serial No.: _____

Customer's Name				Contact Person	
Address				Telephone No.	
Product/Model:		Post Code		Fax No.	
Date of purchase			Expire Date		
Dealer Signature			Customer Signature		